

Debugging Embedded Mixed-Signal Designs Using Mixed Signal Oscilloscopes

Application Note 1562

Introduction

Today's embedded designs based on microcontrollers (MCUs) and digital signal processors (DSPs) often include a combination of analog and digital signal content. Design engineers have traditionally used both oscilloscopes and logic analyzers to test and debug these mixed-signal embedded designs, but a new class of measurement tools known as mixed signal oscilloscopes (MSOs) may offer a better way for you to debug your MCU- and DSP-based designs.

Although MSOs have been on the market for nearly ten years, most engineers have never used one, and many engineers have misconceptions about their benefits and use model. With more oscilloscope vendors introducing hybrid time-domain instruments that merge time-correlated analog and digital measurement capabilities, it is important that you understand the differences between these instruments and that you are aware of what they can and cannot do.

This paper begins by defining mixed signal oscilloscopes, including an overview of the primary applications

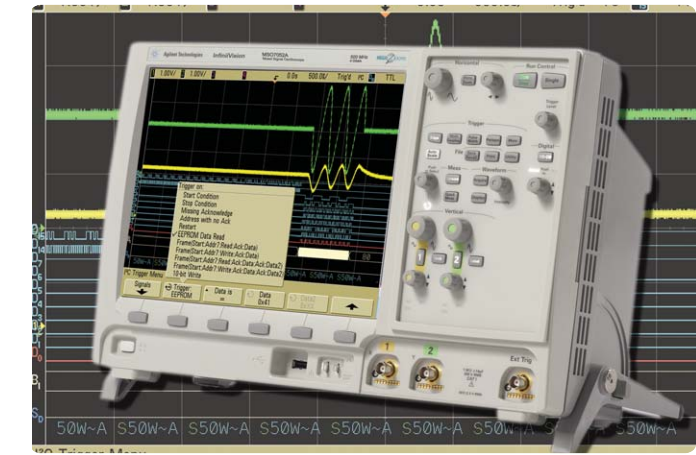

where MSOs should be used. This paper discusses the number of channels, bandwidth, and sample rates required to effectively monitor various analog and digital I/O signals in typical MCU/DSP-based designs, as well as covers the various types of mixed-signal triggering you should look for in an MSO in order to effectively test and debug embedded designs. Using an example of a mixed-signal embedded design based on a 16-bit-wide instruction-set microcontroller (Microchip PIC18), this paper also provides a typical turn-on and debugging methodology using an MSO to verify proper signal quality of a pulsed analog "chirp" output signal generated by the MCU and its associated peripheral hardware based on a variety of analog, digital, and serial I/O (I²C) input conditions.

| | |
|--|-----------|
| Table of Contents | |
| Introduction | 1 |
| What is a mixed signal oscilloscope (MSO)? | 2 |
| Typical MSO measurement applications and required performance | 4 |
| Triggering on mixed signals | 7 |
| Turning on and debugging a real mixed-signal embedded design | 11 |
| Limitation of MSOs | 15 |
| Summary | 16 |
| Glossary | 17 |
| Support, Services, and Assistance .. | 19 |

What is a mixed signal oscilloscope (MSO)?

An MSO is a hybrid test instrument that synergistically combines all of the measurement capabilities of a digital storage oscilloscope (DSO) (including Autoscale, trigger holdoff, infinite-persistence on analog and digital channels, probe/channel de-skew, and equivalent-time sampling) with some of the measurement capabilities of a logic analyzer – into a single instrument. With an MSO, you are able to see multiple time-aligned analog and digital waveforms on the same display, as shown in Figure 1. Although an MSO may lack many of the advanced digital measurement capabilities and the large number

of digital acquisition channels of a full-fledged logic analyzer, MSOs have some unique advantages over both traditional oscilloscopes and logic analyzers for many of today's embedded design debugging applications.

One of the primary advantages of an MSO is its use model. You use an MSO in much the same way you use an oscilloscope. Design and test engineers often avoid using a logic analyzer – even when one may be required to effectively debug a complex design – because of the time required to learn, or relearn, how to use one.

Even if an engineer knows how to use a logic analyzer, setting one up to make particular measurements usually takes much longer than setting up oscilloscope measurements. And finally, the advanced measurement capabilities of a logic analyzer add complexity and are often overkill for many of today's MCU- and DSP-based designs.

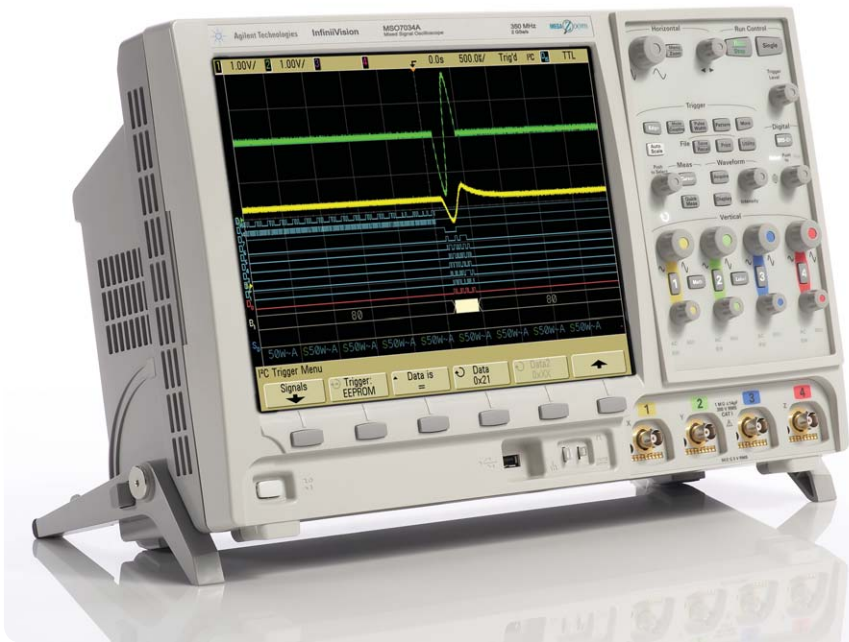

Figure 1. An Agilent 7000 Series mixed signal oscilloscope (MSO)

What is a mixed signal oscilloscope (MSO)? (continued)

Oscilloscopes are the most commonly used test instruments in an R&D environment. All embedded hardware design engineers should have a basic operating knowledge of how to use an oscilloscope to make fundamental signal-quality and timing measurements of their mixed-signal embedded designs. However, 2- and 4-channel oscilloscope measurements are often insufficient to monitor and test critical timing interactions between multiple analog and digital signals. This is where an MSO proves useful.

Because an MSO provides “just enough” logic analyzer measurement capability without adding too much complexity, it is often just the right tool for debugging embedded designs. And as previously mentioned, the use-model of an MSO is that of an oscilloscope. In fact, an MSO can simply be thought of as a multi-channel oscilloscope with some channels (analog) providing lots of vertical resolution (typically 8-bits), with several additional channels

(logic/digital) providing low-resolution (1-bit) measurements. A highly integrated MSO, as opposed to a loosely tethered two-box, mixed-signal measurement solution, should be user-friendly, provide fast waveform update rates, and operate more like an oscilloscope – not like a logic analyzer.

One important characteristic of all oscilloscopes is waveform update rate, which can directly affect the usability of an instrument. Attempting to operate a scope that is slow and unresponsive can be frustrating, and sluggish response limits usability. For an instrument’s display and user-controls to look and feel responsive, waveform update rates should be in the range of 20 waveforms per second or higher. This applies to DSOs as well as MSOs. This means that when oscilloscope vendors port logic acquisition channels into a DSO to create an MSO, waveform update rates should not be sacrificed. Otherwise, the traditional oscilloscope use-model will also be sacrificed. Mixed-signal

measurement solutions based on two-box solutions and/or external logic pods linked via an external communication bus such as USB tend to be very unresponsive and difficult to use. MSOs based on a highly integrated hardware architecture will tend to be much more responsive and easier to use.

For more detailed information about the importance of waveform update rates, download Agilent’s Application Note #1604, “Evaluating Oscilloscopes for Best Signal Visibility.”

Although the first step in evaluating which MSO to purchase may be to compare features and measurement performance in each vendor’s printed and online literature (data sheets), the only way to truly evaluate the usability and responsiveness of an instrument is to actually use it yourself.

Typical MSO measurement applications and required performance

Although MSOs are a great tool for capturing analog and digital signals on mixed-signal devices such as analog-to-digital converters (ADCs) and digital-to-analog converters (DACs), their primary measurement applications involve verifying and debugging MCU/DSP-based mixed-signal designs that have embedded address and data buses. Figure 2 shows a block diagram of a typical mixed-signal embedded design with a microcontroller at its core.

Although microcontrollers and DSPs are often thought of as simply digital control and processing devices, most MCUs and DSPs today are actually mixed-signal devices that often include embedded analog circuitry. Signals that need to be monitored and verified in

systems such as this include analog I/O, digital parallel I/O ports, and digital serial communication buses, such as I²C and SPI.

Note that the block diagram shown in Figure 2 does not show any address or data bus signals. This is because most MCUs and DSPs have an internal bus structure that also includes embedded memory (RAM and ROM).

Because today's MSOs typically feature 16 channels of digital acquisition, some engineers mistakenly assume that MSOs are limited to 8-bit processing applications (8-bit data + 8-bit address = 16 channels). But MSOs are primarily used to monitor analog and digital I/O, which are usually all the signals that are available in

MCU- and DSP-based designs. Don't attempt to relate the number of digital channels of acquisition in an MSO to the number of bits of processing in an internal bus-based MCU or DSP, because it's usually irrelevant. Sixteen channels of digital acquisition, along with two to four channels of analog acquisition and triggering, is usually more than enough to monitor and verify specific/dedicated functions of 8-bit, 16-bit, and sometimes even 32-bit MCU/DSP-based designs.

Monitoring parallel address and data lines in an external bus-based design, such as a computer based on a 32-bit microprocessor, is not the primary measurement application of MSOs.

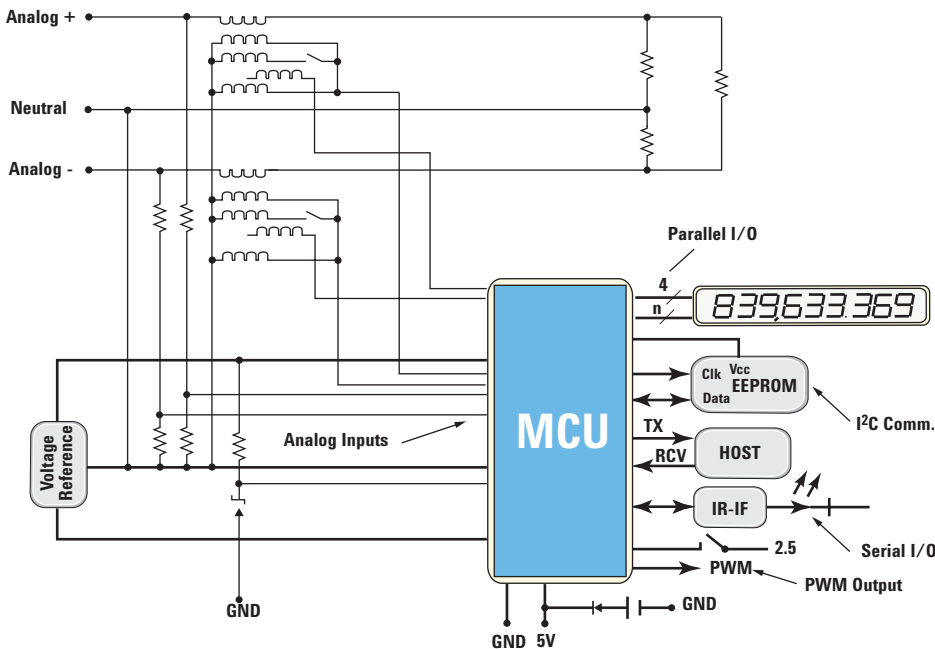

Figure 2. Typical MCU-based embedded design

Typical MSO measurement applications and required performance (continued)

If you need to capture multiple address and data bus signals to verify timing and source-code flow in an external bus-based system, a logic analyzer with state analysis and disassembly may be a better measurement tool for you. And if you also need to time-correlate analog signals and/or analog characteristics of digital signals at the same time, there are two-box solutions (scope + logic analyzer) available from multiple vendors that will import oscilloscope waveforms into the logic analyzer with a time-correlated display. But with this type of higher-performance two-box test solution, you must also accept the more complex use-model of a logic analyzer including slow or single-shot waveform update rates.

But even in 32-bit systems with external memory devices, an MSO with 16 logic-timing channels, along with 2 to 4 analog channels, can often be sufficient to measure critical timing parameters. Figure-3 shows an example of how an MSO was used to verify a high-speed memory device (SDRAM) setup time in a 32-bit system (IBM PowerPC 405GP). Only four digital channels of the MSO were required to qualify the measurement on specific read and write instructions (CS, RAS, CAS, and WE) using the MSO's pattern triggering capabilities. The scope's analog channels were used to further qualify triggering on an edge of the high-speed clock signal and to perform critical timing

measurements on the 100-MHz clock signal (top/yellow trace) relative to a particular data signal (middle/green trace), resulting in a measured setup time of 8-ns on this external memory device. This particular measurement would be impossible to perform with a conventional 2- or 4-channel DSO, and it would be a time-consuming task with a logic analyzer linked to a high-speed oscilloscope.

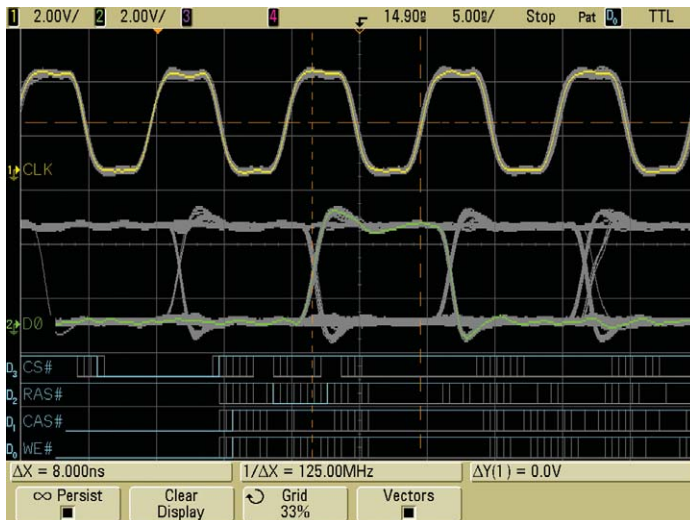

Figure 3. Performing a critical setup time measurement in a 32-bit system using an MSO

Typical MSO measurement applications and required performance (continued)

The analog and digital acquisition performance of the MSO is more important than the number of channels for these types of signal integrity measurements in mixed-signal embedded designs. The most fundamental specifications of an oscilloscope's analog acquisition performance are bandwidth and sample rate. For reasonably accurate analog measurements, a scope's bandwidth should be at least five times the highest clock and update rate in your system. For instance, if you need to monitor a digital signal with a maximum toggle/clock frequency of 200-MHz with your oscilloscope's analog channels, you need an analog bandwidth of 1-GHz in order for the scope to capture the fifth harmonic with reasonable accuracy. And for real-time/single-shot measurements, the scope's sample rate should be approximately four times higher than the scope's bandwidth, or faster. For more detailed information about the relationship between a scope's bandwidth and sample rate, download Agilent's Application Note # 1588 "Choosing an Oscilloscope with the Right Bandwidth for your Application," and Application Note # 1587, "Evaluating Oscilloscope Sample Rate vs. Sampling Fidelity: How to make the most Accurate

Digital Measurements." Unfortunately, some oscilloscope and logic analyzer users do not fully comprehend the required digital acquisition performance of MSOs and logic analyzers. It is important for the digital acquisition performance of an MSO to be commensurate with the scope's analog acquisition performance. It just doesn't make sense to combine a high-performance oscilloscope with a low-performance logic-timing analyzer. Agilent recommends that an MSO's digital/logic acquisition system provide sample rates that are at least twice the bandwidth of the scope's analog channels of acquisition. For the example we just discussed where a 1-GHz oscilloscope is required to capture analog characteristic of digital signals with toggle/clock rates of 200-MHz, capturing the same signals on the logic/digital channels of the MSO with reasonable timing accuracy requires a 2-GSa/s sample rate on the digital/logic channels.

When you use logic/digital acquisition channels, measurement resolution is limited to \pm one sample period.

For example, if you are attempting to capture digital signals with a maximum toggle/clock rate of 200-MHz (period = 5-ns), each high or low pulse can be as narrow as 2.5-ns (assuming a 50% duty cycle). This means that if your MSO's digital acquisition system samples at a maximum rate of 2-GSa/s, then timing measurements on each edge of a pulse can be in error by as much as \pm 500-ps producing a worst-case peak-to-peak error of 1-ns for delta-time measurements, which is 40% error on a 2.5-ns pulse. We believe that exceeding 40% timing errors is unacceptable for digital acquisition channels of an MSO or logic analyzer, which is why we recommend that digital channel acquisition sample rates be at least twice the bandwidth of the scope, or higher.

In addition to bandwidth and sample rate, another critical factor to consider is probing bandwidth, including both analog and digital system probing. Capturing analog or digital signals with significant frequency content in excess of 500-MHz requires active probing on analog channels. Likewise, digital acquisition systems must have probes that can deliver higher frequency signals to the digital system's sampling circuitry in order to reliably capture every pulse within higher frequency pulse trains.

Triggering on mixed signals

More channels of acquisition in an MSO (compared to a DSO) means that you now have more triggering possibilities in order to zero-in on specific analog and digital I/O signal interaction. Although an MSO can't even begin to approach the complex triggering capabilities of a high-performance logic analyzer, MSO triggering goes far beyond the limited triggering of a standard 2- or 4-channel oscilloscope.

Most MSOs and mixed-signal measurement solutions on the market today are able to trigger on at least one level of parallel pattern trigger conditions, and some provide up to two levels of pattern sequence triggering with reset conditions. But even when you use relatively simple one-level pattern triggering, you will find big

differences in triggering capabilities between various MSOs/mixed-signal measurement solutions. First of all, it is important that an MSO is able to trigger on a combination of analog and digital inputs. Some loosely tethered mixed-signal measurement solutions are only able to reliably trigger across one side of the acquisition system or the other due to significant signal skew between analog channels and logic channels. In other words, you may only be able to trigger your oscilloscope on a traditional analog trigger condition, or trigger on just a parallel digital condition – not both. MSOs should provide mixed-signal triggering capabilities with precise time-alignment between analog channels and digital channels of triggering. The high-speed setup time measurement on the external SDRAM

device previously shown in Figure-3 illustrates one example where precise time-aligned mixed-signal triggering (analog and digital) is required. Later in this paper we will show another example where it is necessary to trigger on mixed-signal conditions in order to synchronize the oscilloscope's acquisition on a specific output phase of a DAC controlled by an MCU.

Triggering on mixed signals (continued)

Another important factor to consider in an MSO is whether or not its pattern triggering includes any type of time qualification. In addition to entry and/or exit trigger qualification, pattern trigger conditions should also include a minimum time-qualification condition. The best way to illustrate this is by showing examples of scopes with and without time qualification. Figure-4 shows an example of an oscilloscope with an external mixed-signal option, but without time-qualification triggering. Figure-5 shows an example of an Agilent MSO with minimum time-qualification triggering.

Minimum time qualification is important in order to avoid triggering on transitional/unstable conditions. When parallel digital signals change states, switching may be nearly simultaneous – but not exactly simultaneous – but not exactly simultaneous. In addition to limited rising and falling edge speeds when signals are neither high nor low, there may also be slight delays between signals even in the best-designed systems. This means that there will always be transitional/unstable signal conditions in your system when signals are switching. You will probably want your DSO/MSO or logic analyzer to avoid triggering on these unstable conditions if possible.

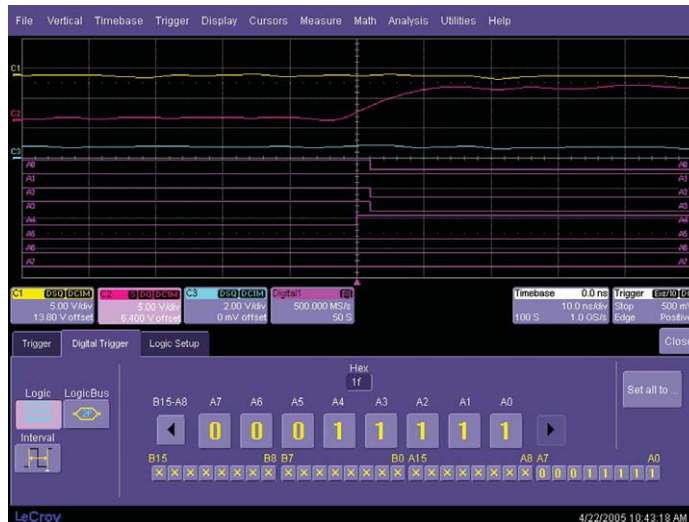

Figure 4. Without time-qualification, the scope triggers on unstable/transitional states (LeCroy WaveRunner with MSO option).

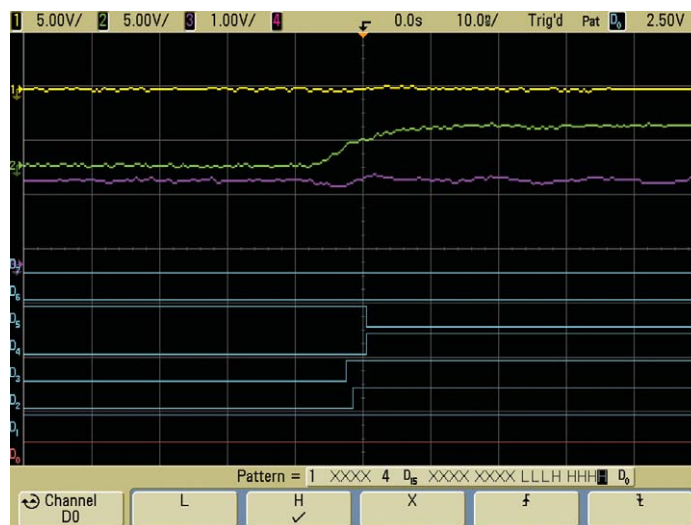

Figure 5. With minimum time-qualification, the Agilent MSO does not trigger on unstable conditions.

Triggering on mixed signals (continued)

Figure 4 shows an example of an oscilloscope that lacks time-qualification pattern triggering. The scope was set up to trigger on an 8-bit binary pattern: 0001 1111. Looking closely at center-screen (the trigger point), you can see slight delays between the various digital traces (purple). Because of these slight signal delays, the scope detects the 0001 1111 pattern for one sample period and triggers the scope. But this was an unstable/transitional condition. Although the oscilloscope usually triggers on the desired stable pattern condition, it sometimes triggers on unstable/transitional conditions because it lacks any type of time-qualification triggering.

Figure 5 shows an example of an Agilent MSO that includes time-qualification pattern triggering. This oscilloscope is able to reliably trigger on the same LLLH HHHH parallel pattern condition when the pattern is entered, but only after the digital signals have stabilized. This MSO has a default minimum time-qualification of 2-ns. In other words, the pattern must be present for at least 2-ns before being qualified as a stable trigger source, and then the scope will always trigger at the beginning (entry point) of the stabilized pattern. In addition, you can override the default setting of >2-ns and select various time-qualification conditions, including longer qualification times for slower digital systems. Conversely, if you want the MSO to trigger exclusively on unstable conditions, the scope's trigger qualification can be set up to trigger only if a pattern is present for less than a specified time including patterns that are present for less than 2-ns.

Oscilloscopes (including MSOs) have the ability to precisely trigger at analog trigger level/threshold crossing points, while logic analyzers typically use sample-based triggering. Sample-based triggering produces a peak-to-peak trigger jitter/uncertainty of \pm one sample period (worst-case peak-to-peak uncertainty = 2 sample periods). By "sample-based triggering," we mean that the instrument randomly samples the input signal first, and then establishes a trigger reference point based on sampled data. This type of triggering, which produces significant trigger jitter, may be sufficient for some typical logic analyzer measurements, but is unacceptable for either conventional oscilloscope or MSO measurements for viewing repetitive signals.

Triggering on mixed signals (continued)

Figure-6 shows an example of an oscilloscope with a mixed-signal option that generates trigger events based on sampled data. Figure-7 shows an example of an Agilent MSO that utilizes analog hardware comparator triggering across all analog and digital input signals.

In this mixed-signal measurement example, each scope has been set up to trigger on a specific 8-bit pattern condition of an MCU's digital output port synchronized to a rising edge occurrence on digital-input channel D4 (A4). In order to measure the signal integrity of the D4 (A4) signal, an analog channel of the oscilloscope has been set up to "double probe" this same digital signal. As you can see in Figure-6, the scope that digitally triggers based on sampled data generates approximately 4-ns of peak-to-peak trigger jitter, since its

maximum digital/logic-channel sample rate is just 500-MSa/s (± 1 -sample period of uncertainty). Notice the 4-ns of peak-to-peak "smear" in the repetitive analog trace (middle/green trace) using this scope's infinite-persistence display mode.

Figure 7 shows the same repetitive triggering measurements using an Agilent MSO that generates trigger events based on real-time analog comparator hardware technology – not sample-based triggering. With the scope set at 5-ns/div, we can observe a very stable analog trace using this scope's infinite-persistence display mode, even though triggering was established across just the digital/logic-channel inputs of the scope. We can now make much more accurate signal integrity measurements on this repetitive input signal using one of the scope's analog input channels.

The last thing to consider when evaluating various MSOs/mixed signal measurement solutions for your mixed-signal embedded applications is whether or not the oscilloscope is able to trigger on specific address and data transmissions of serial I/O such as I²C and SPI. Serial I/O is very prevalent in today's embedded designs. In the next section of this paper, we will show an example where serial triggering was required to synchronize oscilloscope acquisitions on specific analog output "chirp" signals based on serial input commands in a mixed-signal embedded design.



Figure 6. Sample-based pattern triggering generates 4 ns of trigger jitter (LeCroy WaveRunner with MSO option).

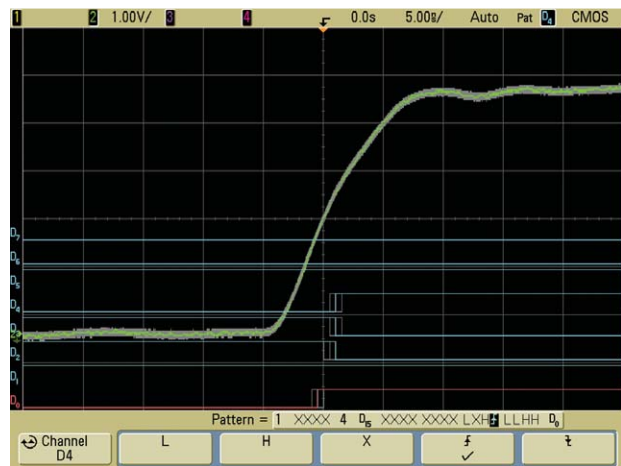

Figure 7. Real-time comparator hardware pattern triggering in an Agilent MSO generates very low trigger jitter.

Turning on and debugging a real mixed-signal embedded design

We will now look at the turn-on and debugging process of a mixed-signal embedded product designed by Solutions-Cubed of Chico, California (USA). Figure-8 shows a block diagram of this product.

At the core of this mixed-signal embedded product is a Microchip PIC18F452-I/PT microcontroller, which operates on an internal 16-bit instruction set. Since this particular MCU has an internal bus structure and includes an embedded analog-to-digital converter (ADC), this mixed-signal device and its associated external circuitry provides a perfect example of using an MSO to turn-on and debug an embedded mixed-signal design.

The ultimate goal of this design was to generate various length, shape, and amplitude analog “chirp” output signals based on a variety of analog, digital, and serial I/O input conditions. (A “chirp” is an RF pulsed analog output signal consisting of a specific number of cycles often found in

aerospace/defense and automotive applications.) The MCU simultaneously monitors the following three inputs to determine the characteristics of the output chirp signal:

1. The status of the system control panel is monitored with one of the MCU’s available parallel digital I/O ports to determine the shape of the output-generated chirp signal (sine, triangular, or square wave).
2. The output level of an acceleration analog input sensor is monitored via one of the MCU’s available ADC inputs to determine the amplitude of the output-generated chirp signal.
3. The status of the serial I²C communication link is monitored with the MCUs dedicated I²C serial I/O port to determine the number of pulses to be generated in the output chirp. This I²C communication input signal is generated from another

intelligent sub-system component from within this embedded design.

Depending on the status of these three analog, digital, and serial inputs, the MCU has been programmed to generate a series of parallel output signals to an external 8-bit DAC to create an analog chirp signal of various amplitudes, shapes, and lengths. The unfiltered stair-step output of the DAC is then fed through an analog low-pass filter to smooth the output signal and reduce noise. In addition, this analog filter induces a predetermined amount of phase shift to the input signal. Finally, the MCU generates a parallel digital output via another available digital I/O port to drive an LCD display that provides the user with system status information.

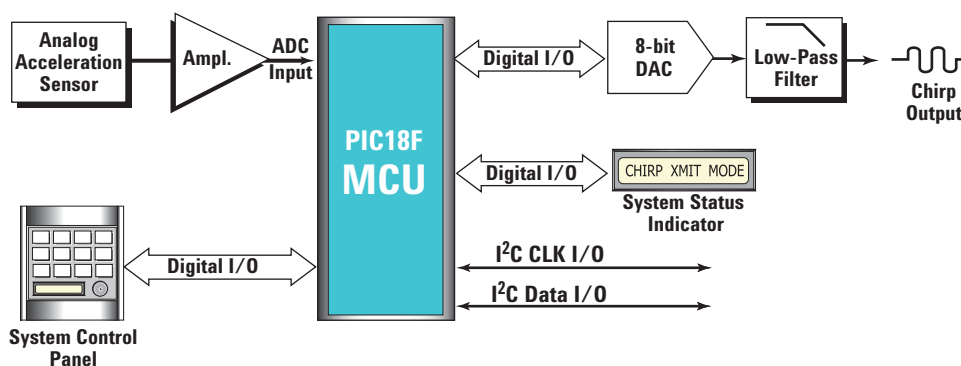

Figure 8. Mixed-signal embedded design that generates analog “chirp” outputs based on analog, digital, and serial I/O.

Turning on and debugging a real mixed-signal embedded design (continued)

The first step in designing/programming the MCU in this design was to configure the MCU's I/O for the appropriate number of analog and digital I/O ports. Note that the embedded designer can trade-off the number of analog I/O for digital I/O ports and vice versa in this particular microcontroller from MicroChip.

Before attempting to code the MCU to monitor various inputs and generate the final specified output signals, the design team decided it might be best to first develop test code to turn on one section/function of the product at a time and verify proper operation and signal integrity before adding interactive complexity. The first section/function turned on and debugged was the external DAC inputs and output and analog filter. In order to verify proper operation of this circuitry and internal firmware,

the MCU was coded to generate a continuous/repetitive sine wave of fixed amplitude, regardless of the input signal conditions.

Figure 9 shows a screen image from an Agilent InfiniiVision Series MSO capturing both the continuous digital inputs to the external DAC (output of MCU digital I/O port), and the stair-step output of the DAC and analog filtered output. Since this particular signal was a relatively low-level output signal utilizing just 16 levels of the 8-bit DAC (256 levels max), we can easily view the stair-step output characteristics of this converter on the oscilloscope's display (top/yellow trace).

This particular acquisition was set up to trigger when the DAC's output reached its highest output level (center-screen). Triggering at this particular point using conventional oscilloscope triggering would be impossible, since scope triggering requires edge transitions. Triggering at this point/phase of the output signal was achieved by establishing a simple one-level pattern trigger condition on the digital input signals that were coincident with the highest output analog level of the external DAC. To trigger at this precise point in the waveform, the designer entered a parallel binary pattern of "HHHL LHHL." Since this MSO employs time-qualified pattern triggering, the scope always triggered at the beginning of the specified pattern and never triggered on unstable/transitional conditions.

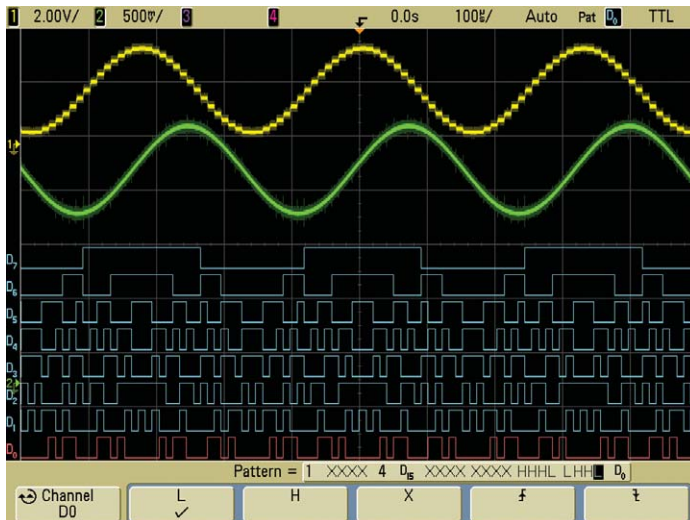

Figure 9. Agilent InfiniiVision Series MSO captures parallel digital input and analog output of MCU-controlled DAC.

Turning on and debugging a real mixed-signal embedded design (continued)

Figure 10 shows a trigger condition of the MSO set to trigger precisely at the DAC's 50% output level point using pattern triggering on the parallel digital input signals in addition to an analog trigger condition. As we mentioned earlier, not all MSOs/mixed-signal measurement solutions permit combinational mixed-signal triggering on both analog and digital conditions. But since there are two analog output conditions at the same level (50% rising level and 50% falling level), triggering coincident with either the rising or falling point required more than just pattern triggering on the 8-bit input pattern. With the addition of qualifying on a "low" level on analog channel 2 (middle/green trace), the scope was able to trigger at the desired phase using a combination of analog and digital pattern triggering. Note that analog signals are considered "high" when they are above the analog trigger level and "low" when they are below the trigger level.

Also shown in Figure 10 are automatic parametric measurements on the filtered output signal including amplitude, frequency, and phase shift relative to the unfiltered DAC output.

After turning on and verifying proper operation of the external DAC and analog filtering, the next step in this design/turn-on process was to write code to generate a specific number of non-repetitive sine wave pulses (chirps) based on a serial I²C input. Figure-11 shows an overlay (infinite-persistence) of various length chirps using standard oscilloscope edge triggering. Unfortunately, with conventional oscilloscope edge triggering it is impossible to qualify triggering on specific length chirps.

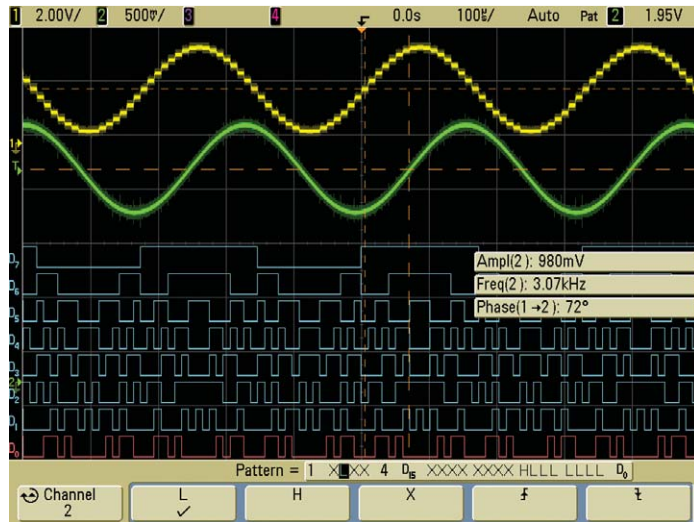

Figure 10. Agilent MSO triggers at the 50% crossing point using a combination of analog AND digital pattern triggering.

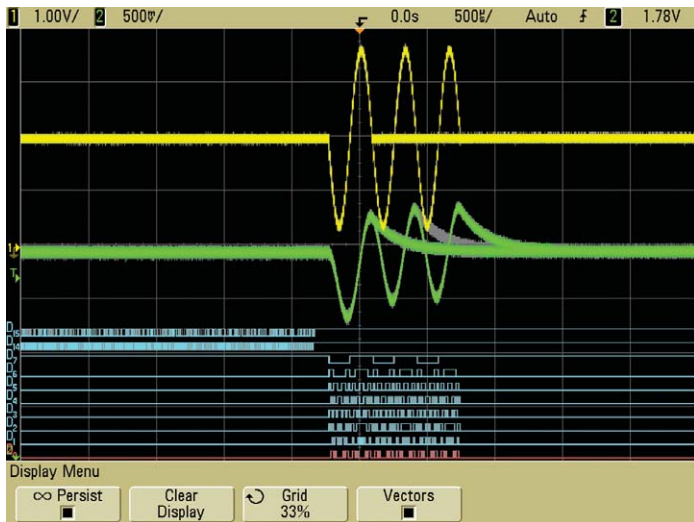

Figure 11. Conventional oscilloscope edge triggering fails to synchronize on specific-length chirps.

Turning on and debugging a real mixed-signal embedded design (continued)

Using the I²C triggering capability, the Agilent MSO can synchronize its acquisitions on specific serial input conditions that instruct the MCU to generate specific length (number of pulses) output chirps. This is shown in Figures 12 and 13.

Figure 12 shows the scope's ability to trigger on a 3-cycle chirp with I²C triggering on address and data serial content, and Figure 13 shows the scope's ability to trigger on a 1-cycle chirp. Digital channels D14 and D15 have been defined as the I²C clock and data input triggering signals respectively. Actually, any of the 16 digital or 2 to 4 analog scope channels could have been defined to trigger serially on these two input signals. While monitoring the serial input and analog output signals, D0 through D7 have been set up to monitor the external DAC input (MCU output) signals (bottom eight blue and red traces) shown in Figures-12 and 13.

Although not shown, another analog channel of the oscilloscope could have been set up to simultaneously probe and acquire the analog input signal from the acceleration sensor that determines the output signal amplitude. In addition, unused MSO digital channels could have been used to monitor and/or further qualify triggering on the digital control panel inputs and/or the LCD output driver signals.

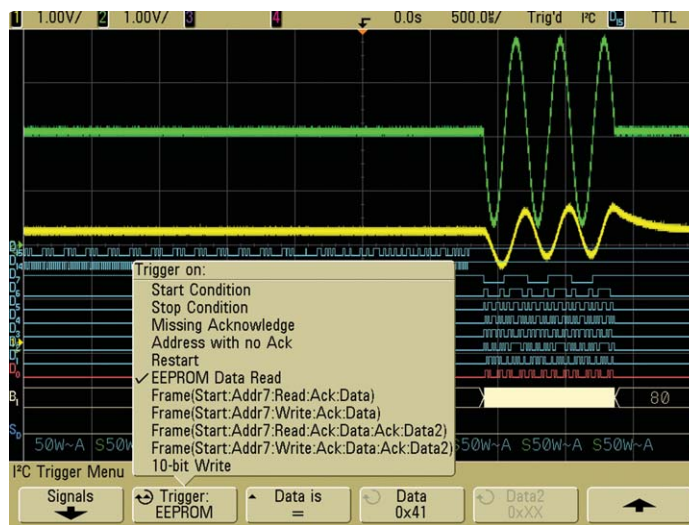

Figure 12. Triggering on a 3-cycle chirp with I²C triggering and decode in an Agilent MSO.

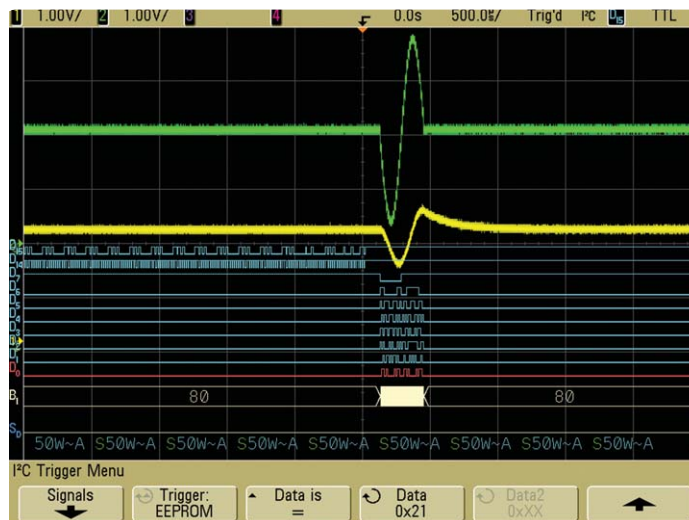

Figure 13. Triggering on a 1-cycle chirp with I²C triggering and decode in an Agilent MSO.

Limitation of MSOs

MSOs on the market today have analog acquisition bandwidths ranging from 100-MHz up to 1-GHz, and standard digital channel acquisition sample rates up to 2-GSa/s. If your embedded mixed-signal debugging measurement applications require higher performance than this, then you may need to use a two-box measurement solution consisting of either a higher performance scope and/or a higher performance logic analyzer. Although you may be able to time-correlate waveform displays of these two higher-performance measurement solutions using a time-correlation fixture/option, you will lose the familiar use-model of an MSO that includes fast waveform update rates and easy-to-use oscilloscope controls. Figure-14 shows an example of a time-correlated two-box solution that imports oscilloscope waveforms into the logic analyzer's display.

As mentioned earlier, when it is necessary to monitor and debug external bus-based processor systems with a large number of digital acquisition channels and/or when state analysis is required to trace source code, a higher-performance logic analyzer with a time-correlated imported oscilloscope waveforms may be a better measurement tool.

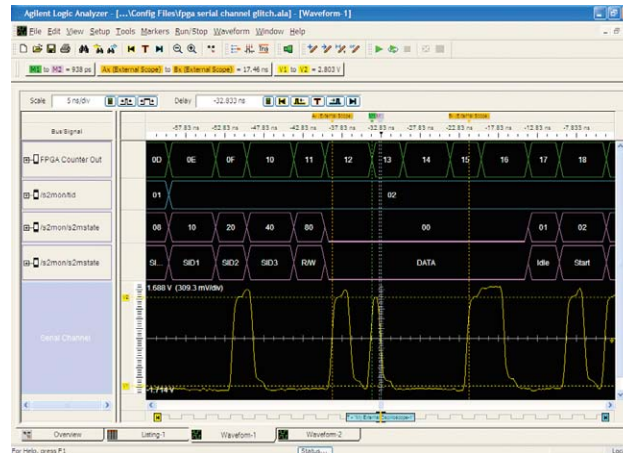

Figure 14. A time-correlated display of an oscilloscope's waveforms ported into a logic analyzer's display.

Summary

Mixed signal oscilloscopes (MSOs) are the new tools-of-choice for debugging and verifying proper operation of many of today's MCU- and DSP-based mixed-signal designs. With time-correlated displays of both analog and digital waveforms in a single integrated instrument, along with powerful mixed-signal triggering across all analog and digital channels, an MSO can often enable designers to more quickly debug their mixed-signal embedded designs using a familiar tool based on an oscilloscope's user-interface/use-model.

With more MSOs and hybrid mixed-signal measurement tools coming on the market today, it is important that you carefully evaluate the measurement capabilities and usability of these instruments before making a purchase decision. You should look for the following seven characteristics:

1. An MSO should operate like a familiar oscilloscope – not like a logic analyzer.
2. An MSO should have all of the measurement capabilities of an oscilloscope without sacrificing features such as Autoscale, trigger holdoff, infinite-persistence (on analog and digital channels), probe/channel de-skew, and equivalent-time sampling.
3. An MSO should provide fast waveform update rates like an oscilloscope – not slow updates like a logic analyzer.
4. An MSO should have digital/logic-channel acquisition system performance (sample rate and probing bandwidth) commensurate with the performance of the analog acquisition system of the oscilloscope.
5. An MSO should be able to trigger across both analog and digital channels (mixed-signal triggering) with precise time-alignment.
6. An MSO should be able to trigger on patterns based on a minimum qualification time in order to avoid triggering on unstable/transitional digital switching conditions.
7. An MSO should provide both analog and digital triggering that is based on real-time analog comparator technology – not sample-based triggering which produces significant trigger jitter on repetitive analog waveforms.

Glossary

ADC Analog-to-digital converter, sometimes referred to as an A-to-D

Analog I/O Real-time analog input and output signals of a microcontroller (MCU) or digital signal processor (DSP)

Chirp An RF-pulsed analog signal consisting of a specific number of pulses

DAC Digital-to-analog converter, sometimes referred to as a D-to-A

Digital I/O Latched input and output signals of a microcontroller (MCU) or digital signal processor (DSP)

DSO Digital storage oscilloscope that acquires and displays analog characteristics of input signals using either real-time or equivalent-time sampling techniques

DSP Digital signal processor

I²C Inter-integrated circuit bus, which is a common 2-wire serial bus that utilizes a self-arbitration protocol

MSO Mixed signal oscilloscope that synergistically combines all of the measurement capabilities of an oscilloscope with some of the measurement capabilities of a logic analyzer and includes a time-correlated display of both analog and digital waveforms

MCU Microcontroller unit

Qualified pattern triggering Triggering at a specific location within a digital parallel pattern (usually entry or exit points) and ensuring that an input pattern has stabilized with a minimum time qualification (present for >x time) before generating a trigger event so that the scope or logic analyzer does not trigger on unstable/transitional input switching conditions

RAM Random access memory

Real-time analog hardware comparator triggering Precise triggering that occurs before and separate from digital acquisition sampling to insure reliable/stable triggering with minimal trigger uncertainty/jitter

ROM Read-only memory

Sample-based pattern triggering Pattern triggering that is based on sampled data that will induce as much as \pm one sample period of trigger uncertainty/jitter

SDRAM Synchronous dynamic random access memory

SPI Serial protocol interface

Solutions Cubed, LLC

Agilent Technologies would like to thank Solutions Cubed, LLC of Chico, California, for providing the block diagram and measurement example of the mixed-signal MCU-based “chirp” design discussed in this paper. Agilent Technologies has worked closely with Solutions Cubed on various mixed-signal embedded design projects. Agilent currently offers an MSO training board based on the embedded chirp design developed by Solutions Cubed and documented in this application note. The MSO training board (N2918A), which can be purchased directly from Agilent

Technologies, not only provides signals to train you on how to use an MSO, but also includes a variety of signals that demonstrate other important characteristics of oscilloscopes including glitch capture, waveform update, and display quality. Using this new MSO training board along with the easy-to-follow user’s guide, you can quickly become familiar with how to effectively use an MSO in about one to two hours.

Solutions Cubed can provide mixed-signal hardware and software embedded design services/consulting according to your specified

requirements. Contact Solutions-Cubed directly:

Solutions Cubed
256 East 1st Street
Chico, CA 95928
USA
+1 (530) 891-1643
www.solutions-cubed.com

Related Literature

| Publication Title | Publication Type | Publication Number |
|--|------------------|--------------------|
| <i>Agilent Technologies Oscilloscope Family Brochure</i> | Data sheet | 5989-7650EN |
| <i>Agilent 7000 Series InfiniiVision Oscilloscopes</i> | Data sheet | 5968-7736EN |
| <i>Agilent 6000 Series InfiniiVision Oscilloscopes</i> | Data sheet | 5988-2000EN |
| <i>Agilent 5000 Series InfiniiVision Oscilloscopes</i> | Data sheet | 5968-6110EN |
| <i>Agilent InfiniiVision Series Oscilloscope Probes and Accessories</i> | Data sheet | 5989-8153EN |
| <i>Evaluating Oscilloscopes for Best Signal Visibility</i> | Application note | 5989-7885EN |
| <i>Using an Agilent InfiniiVision MSO to Debug an Automotive CAN Bus</i> | Application note | 5989-5049EN |
| <i>Choosing an Oscilloscope with the Right Bandwidth for your Applications</i> | Application note | 5989-5733EN |
| <i>Evaluating Oscilloscope Sample Rates vs. Sampling Fidelity</i> | Application note | 5989-5732EN |
| <i>Evaluating Oscilloscope Vertical Noise Characteristics</i> | Application note | 5989-3020EN |

To download these documents, insert the publication number in the URL:
<http://cp.literature.agilent.com/litweb/pdf/xxxx-xxxxEN.pdf>

Product Web site

For the most up-to-date and complete application and product information, please visit our product Web site at:
www.agilent.com/find/scopes



Agilent Email Updates

www.agilent.com/find/emailupdates

Get the latest information on the products and applications you select.



Agilent Direct

www.agilent.com/find/agilentdirect

Quickly choose and use your test equipment solutions with confidence.



www.agilent.com/find/open

Agilent Open simplifies the process of connecting and programming test systems to help engineers design, validate and manufacture electronic products. Agilent offers open connectivity for a broad range of system-ready instruments, open industry software, PC-standard I/O and global support, which are combined to more easily integrate test system development.



www.lxistandard.org

LXI is the LAN-based successor to GPIB, providing faster, more efficient connectivity. Agilent is a founding member of the LXI consortium.

Windows® is a U.S. registered trademark of Microsoft Corporation.

Remove all doubt

Our repair and calibration services will get your equipment back to you, performing like new, when promised. You will get full value out of your Agilent equipment throughout its lifetime. Your equipment will be serviced by Agilent-trained technicians using the latest factory calibration procedures, automated repair diagnostics and genuine parts. You will always have the utmost confidence in your measurements.

Agilent offers a wide range of additional expert test and measurement services for your equipment, including initial start-up assistance onsite education and training, as well as design, system integration, and project management.

For more information on repair and calibration services, go to

www.agilent.com/find/removealldoubt

www.agilent.com

For more information on Agilent Technologies' products, applications or services, please contact your local Agilent office. The complete list is available at:

www.agilent.com/find/contactus

Phone

Americas

| | |
|---------------|----------------|
| Canada | (877) 894-4414 |
| Latin America | 305 269 7500 |
| United States | (800) 829-4444 |

Asia Pacific

| | |
|-----------|----------------|
| Australia | 1 800 629 485 |
| China | 800 810 0189 |
| Hong Kong | 800 938 693 |
| India | 1 800 112 929 |
| Japan | 81 426 56 7832 |
| Korea | 080 769 0800 |
| Malaysia | 1 800 888 848 |
| Singapore | 1 800 375 8100 |
| Taiwan | 0800 047 866 |
| Thailand | 1 800 226 008 |

Europe

| | |
|----------------|-------------------------------------|
| Austria | 0820 87 44 11 |
| Belgium | 32 (0) 2 404 93 40 |
| Denmark | 45 70 13 15 15 |
| Finland | 358 (0) 10 855 2100 |
| France | 0825 010 700 |
| Germany | 01805 24 6333* *0.14€/minute |
| Ireland | 1890 924 204 |
| Italy | 39 02 92 60 8484 |
| Netherlands | 31 (0) 20 547 2111 |
| Spain | 34 (91) 631 3300 |
| Sweden | 0200-88 22 55 |
| Switzerland | (French) 44 (21) 8113811 (Opt 2) |
| Switzerland | (German) 0800 80 53 53 (Opt 1) |
| United Kingdom | 44 (0) 7004 666666 |

Other European countries:

www.agilent.com/find/contactus

Revised: March 23, 2007

Product specifications and descriptions in this document subject to change without notice.

© Agilent Technologies, Inc. 2001, 2008
Printed in USA, March 20, 2008
5989-3702EN



Agilent Technologies