PXle-4144

Specifications

2025-09-24



Contents

PXIe-4144 Specifications 3

PXIe-4144 Specifications

Definitions

Warranted specifications describe the performance of a model under stated operating conditions and are covered by the model warranty.

Characteristics describe values that are relevant to the use of the model under stated operating conditions but are not covered by the model warranty.

- **Typical** specifications describe the performance met by a majority of models.
- **Nominal** specifications describe an attribute that is based on design, conformance testing, or supplemental testing.

Specifications are **Warranted** unless otherwise noted.

Conditions

Specifications are valid under the following conditions unless otherwise noted.

- Ambient temperature¹ of $23\text{ °C} \pm 5\text{ °C}$
- Calibration interval of 1 year
- 30 minutes warm-up time
- Self-calibration performed within the last 24 hours
- niDCPower Aperture Time property or NIDCPOWER_ATTR_APERTURE_TIME attribute set to 2 power-line cycles (PLC)
- Fans set to the highest setting if the PXI Express chassis has multiple fan speed settings

PXIe-4144 Pinout

The following figure shows the terminals on the PXIe-4144 connector.

1. The ambient temperature of a PXI system is defined as the temperature at the chassis fan inlet (air intake).

Figure 5. PXIe-4144 Connector Pinout

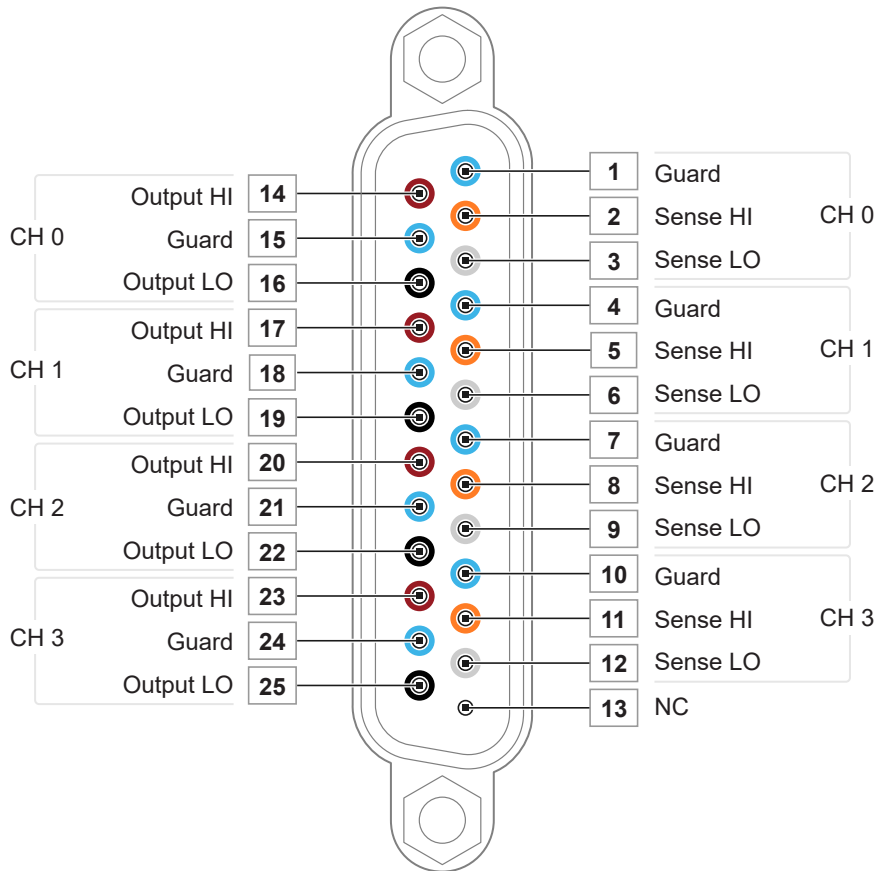

Table 3. Signal Descriptions

Signal Name	Description
CH <0..3> Output HI	HI force terminal connected to channel power stage (generates and/or dissipates power). Positive polarity is defined as voltage measured on HI > LO.
CH <0..3> Guard	Buffered output that follows the voltage of the HI force terminal. Used to drive shield conductors surrounding HI force and Sense HI conductors to minimize effects of leakage and capacitance on low level currents.
CH <0..3> Output LO	LO force terminal connected to channel power stage (generates and/or dissipates power). Positive polarity is defined as voltage measured on HI > LO.
CH <0..3> Sense HI	Voltage remote sense input terminals. Used to compensate for $I \cdot R$ voltage drops in cable leads, connectors, and switches.
CH <0..3> Sense LO	
NC	No Connect.



Note PXIe-4144 channels are bank-isolated from earth ground, but also share a common LO.

Device Capabilities

The following table and figure illustrate the voltage and the current source and sink ranges of the PXIe-4144.

Table 4. PXIe-4144 Current Source and Sink Ranges

Channels	DC Voltage Ranges	DC Current Source and Sink Ranges
0 through 3 [*]	± 6 V	<ul style="list-style-type: none"> • 10 μA • 100 μA • 1 mA • 10 mA • 100 mA • 500 mA
[*] Channels are isolated from earth ground but share a common LO.		

Figure 6. PXle-4144 Quadrant Diagram, All Channels

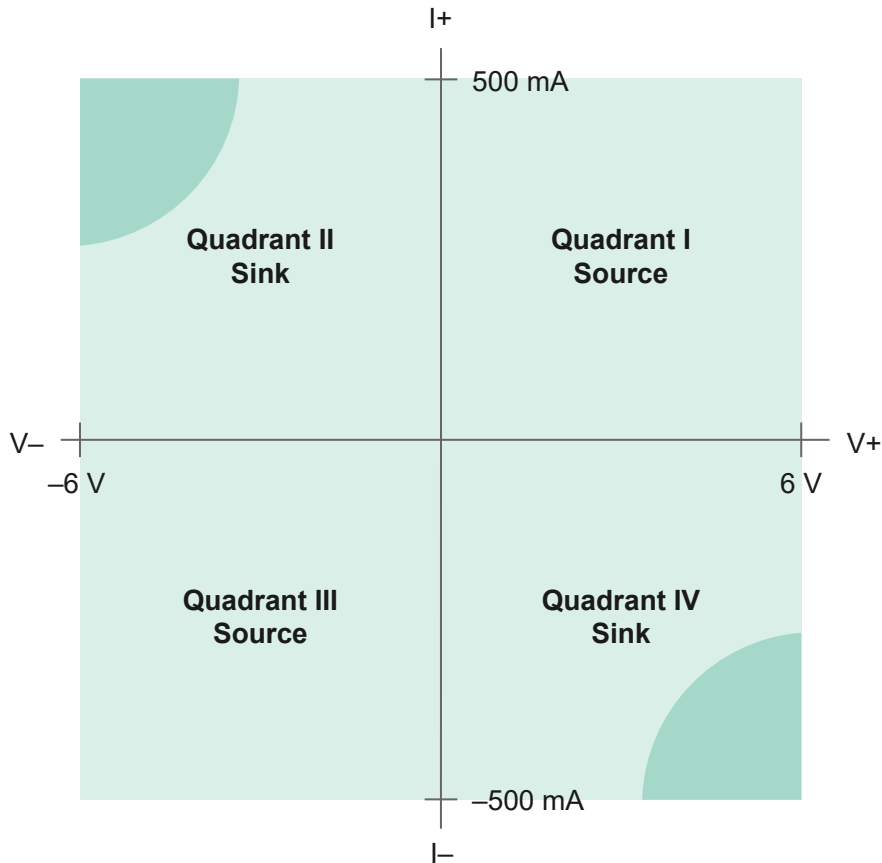

Legend

 Limit power sinking to 7 W per module. Additional derating applies to module sinking power when operating at an ambient temperature of >45 °C.

SMU Specifications

Voltage Programming and Measurement Accuracy/Resolution

Table 5. Voltage Programming and Measurement Accuracy/Resolution

Range	Resolution and noise (0.1 Hz to 10 Hz)	1 Year Accuracy (23 °C ± 5 °C) ± (% of voltage + offset), ² T _{cal} ±5 °C	Tempco ± (% of voltage + offset)/°C, 0 °C to 55 °C
6 V	60 µV	0.1% + 10 mV	0.0005% + 1 µV

2. Accuracy is specified for no load output configurations. Refer to Load Regulation and Remote Sense in the **Additional Specifications** section for additional accuracy derating and conditions.

Related tasks:

- [Calculating SMU Resolution](#)

Related reference:

- [Additional Specifications](#)

Current

Table 6. Current Programming and Measurement Accuracy/Resolution

Range	Resolution and noise (0.1 Hz to 10 Hz)	1 Year Accuracy (23 °C ± 5 °C) ± (% of current + offset), T _{cal} ±5 °C	Tempco ± (% of current + offset)/°C, 0 °C to 55 °C
10 µA	150 pA	0.1% + 6.0 nA	0.002% + 20 pA
100 µA	1 nA	0.1% + 50 nA	0.002% + 200 pA
1 mA	10 nA	0.1% + 0.5 µA	0.002% + 2.0 nA
10 mA	100 nA	0.1% + 5.0 µA	0.002% + 20 nA
100 mA	1 µA	0.1% + 50 µA	0.002% + 200 nA
500 mA	5 µA	0.2% + 250 µA	0.008% + 1 µA

Related tasks:

- [Calculating SMU Resolution](#)

Related reference:

- [Additional Specifications](#)

Calculating SMU Resolution

Refer to the following figure as you complete the following steps to derive a resolution in absolute units:

Figure 7. Noise and Resolution versus Measurement Aperture, Typical

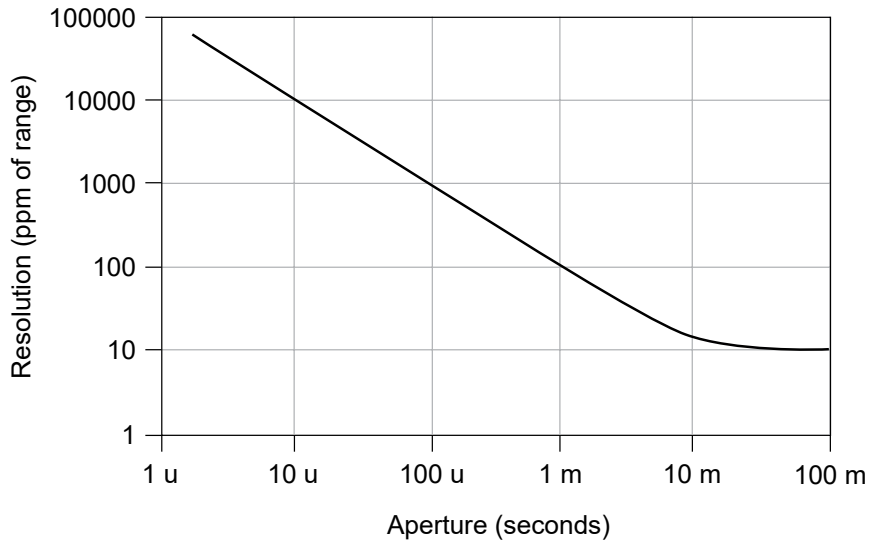

1. Select a voltage or current range.
2. For a given aperture time, find the corresponding resolution.
3. To convert resolution from ppm of range to absolute units, multiply resolution in ppm of range by the selected range.

Example of Calculating SMU Resolution

The PXIe-4144 has a resolution of 1,000 ppm when set to a 100 μ s aperture time. In the 6 V range, resolution can be calculated by multiplying 6 V by 1,000 ppm, as shown in the following equation:

$$6 \text{ V} * 1,000 \text{ ppm} = 6 \text{ V} * 1,000 * 1 \times 10^{-6} = 6 \text{ mV}$$

Likewise, in the 10 mA range, resolution can be calculated by multiplying 10 mA by 1,000 ppm, as shown in the following equation:

$$10 \text{ mA} * 1,000 \text{ ppm} = 10 \text{ mA} * 1,000 * 1 \times 10^{-6} = 10 \text{ } \mu\text{A}$$

Sinking Power vs. Ambient Temperature Derating

The following figure illustrates sinking power derating as a function of ambient temperature.

Figure 8. Sinking Power vs Ambient Temperature Derating

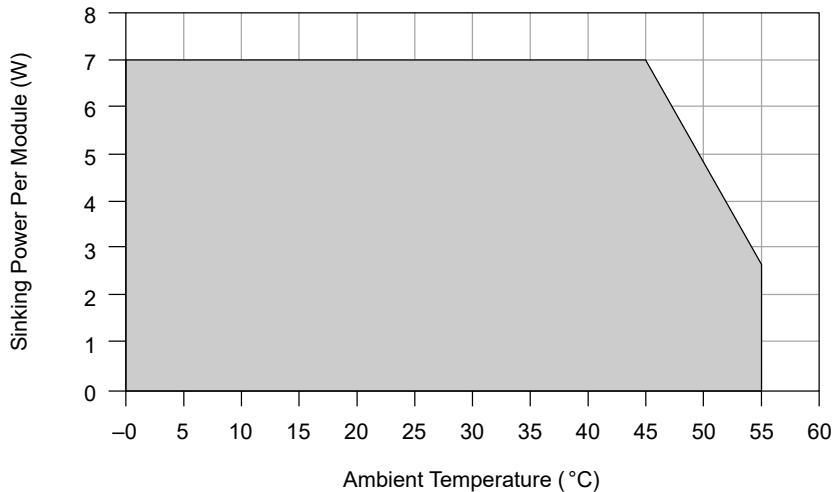

Additional Specifications

Settling time ³	<100 μ s to settle to 0.1% of voltage step, device configured for fast transient response, typical
Transient response	<100 μ s to recover within ± 20 mV after a load current change from 10% to 90% of range, device configured for fast transient response, typical
Wideband source noise ⁴	1.5 mV RMS, typical <20 mV _{pk-pk} , typical
Cable guard output impedance	10 k Ω , typical

Remote sense

Voltage	Add 0.1% of LO lead drop to voltage accuracy specification
---------	--

3. Current limit set to ≥ 1 mA and $\geq 10\%$ of the selected current limit range.

4. 20 Hz to 20 MHz bandwidth. PXIe-4144 configured for normal transient response.

Current	No additional error due to lead drop
Maximum lead drop	Up to 1 V drop per lead for $ V_{out} \leq 5$ V. For $ V_{out} > 5$ V, keep sum of $ V_{out} $ and total lead drop below 7 V

Load regulation	
Voltage	10 μ V at connector pins per mA of output load when using local sense, typical
Current	20 pA + (1 ppm of range per volt of output change) when using local sense, typical

Isolation voltage, Channel-to-earth ground ⁵	60 VDC, CAT I, verified by dielectric withstand test, 5 s, continuous, characteristic
Absolute maximum voltage between any terminal and LO	20 VDC, continuous

The following figures illustrate the effect of the transient response setting on the step response of the PXIe-4144 for different loads.

5. Channels are isolated from earth ground but share a common LO.

Figure 9. 1 mA Range No Load Step Response, Typical

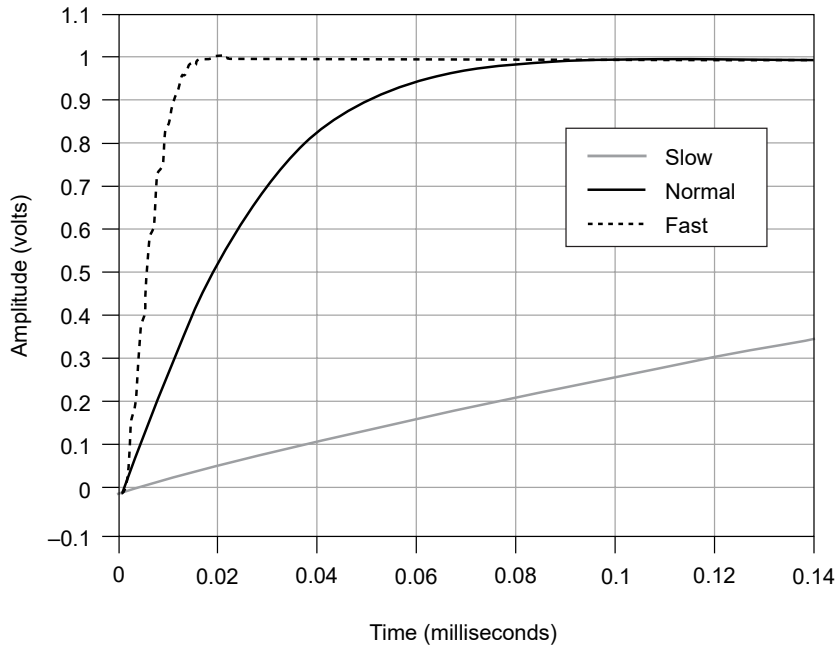
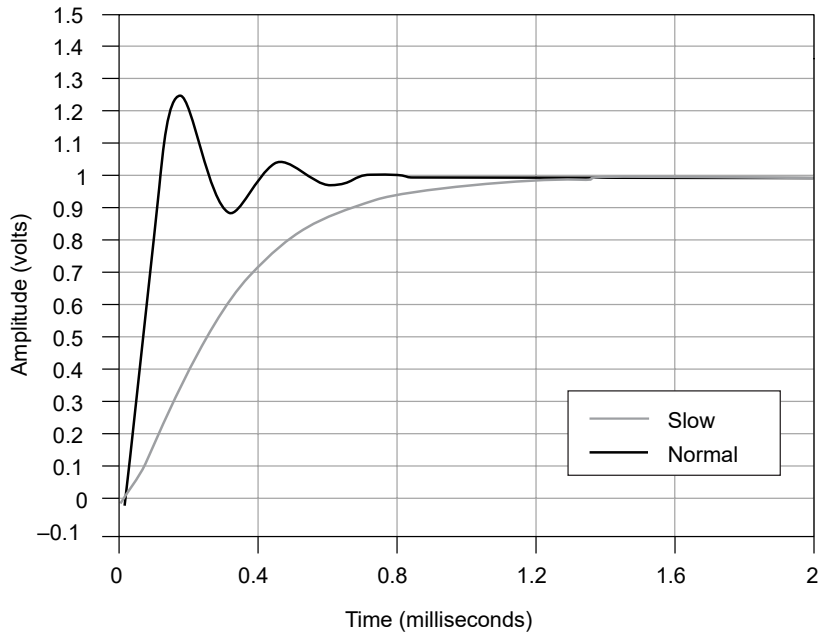

Figure 10. 1 mA Range, 100 nF Load Step Response, Typical



Supplemental Specifications

Measurement and Update Timing

Available sample rates ⁶	(600 kS/s)/N
-------------------------------------	--------------

where

- $N = 6, 7, 8, \dots, 2^{20}$
- S is samples

Sample rate accuracy	±50 ppm
Maximum measure rate to host ⁷	600,000 S/s per channel, continuous
Maximum source update rate⁸	
Sequence length <300 steps per iteration	100,000 updates/s per channel
Sequence length ≥300 steps per iteration	100,000 updates/s per board
Input trigger to	
Source event delay	5 μs

6. When source-measuring, both the NI-DCPower Source Delay and Aperture Time properties affect the sampling rate. When taking a measure record, only the Aperture Time property affects the sampling rate.

7. Load dependent settling time is not included. Normal DC noise rejection is used.

8. As the source delay is adjusted or if advanced sequencing is used, maximum source update rates may vary.

Source event jitter	1.7 μ s
Measure event jitter	1.7 μ s

Triggers

Input triggers	
Types	Start Source Sequence Advance Measure
Sources (PXI trigger lines 0 to 7)	
Polarity	Configurable
Minimum pulse width	100 ns, nominal
Destinations⁹ (PXI trigger lines 0 to 7)	
Polarity	Active high (not configurable)
Minimum pulse width	>200 ns, nominal
Output triggers (events)	

9. Input triggers can come from any source (PXI trigger or software trigger) and be exported to any PXI trigger line. This allows for easier multi-board synchronization regardless of the trigger source.

Types	Source Complete Sequence Iteration Complete Sequence Engine Done Measure Complete
Destinations (PXI trigger lines 0 to 7)	
Polarity	Configurable
Pulse width	Configurable between 250 ns and 1.6 μ s, nominal



Note Pulse widths and logic levels are compliant with *PXI Express Hardware Specification Revision 1.0 ECN 1*.

Calibration Interval

Recommended calibration interval	1 year
----------------------------------	--------

Physical

Dimensions	3U, one-slot, PXI Express/CompactPCI Express module 2.0 cm \times 13.0 cm \times 21.6 cm (0.8 in. \times 5.1 in. \times 8.5 in.)
Weight	408 g (14.39 oz)

Front panel connectors	25-position D-SUB, male
------------------------	-------------------------

Power Requirements

PXI Express power requirement	2.1 A from the 12 V rail and 2.9 A from the 3.3 V rail
-------------------------------	--

Environmental Characteristics

Table 7. Temperature

Operating	0 °C to 55 °C
Storage	-40 °C to 70 °C

Table 8. Humidity

Operating	10% to 70%, noncondensing. Derate 1.3% per °C above 40 °C
Storage	5% to 95%, noncondensing

Table 9. Pollution Degree

Pollution degree	2
------------------	---

Table 10. Maximum Altitude

Maximum altitude	2,000 m (800 mbar) (at 25 °C ambient temperature)
------------------	---

Table 11. Shock and Vibration

Operating vibration	5 Hz to 500 Hz, 0.3 g RMS
Non-operating vibration	5 Hz to 500 Hz, 2.4 g RMS
Operating shock	30 g, half-sine, 11 ms pulse