

Anritsu Advancing beyond

Site Master™

Handheld Cable and Antenna Analyzer with Spectrum Analyzer

MS2089A

5 kHz to 4 GHz / 6 GHz
Cable & Antenna Analyzer

9 kHz to 4 GHz / 6 GHz
Spectrum Analyzer

MS2085A

5 kHz to 4 GHz / 6 GHz
Cable & Antenna Analyzer





New Anritsu Site Master™

Site Master™ MS2085A/MS2089A

The performance you need with the measurements you demand in a field-portable spectrum/cable and antenna analyzer from the company you know and trust



Tested

Precise measurements of cable and antenna return loss with built in fault location to facilitate the commissioning and maintenance of broadcast, LMR, and cellular radio transmission networks.



Trusted

Anritsu launched the first Site Master in 1995, the world's first instrument designed specifically for field testing of cables and antennas and through continuous development of the instrument continues to be recognized as the gold standard by field engineers worldwide.



Supported

Delivery of certified training courses for field technicians plus access to expert and experienced application engineers to support you from first measurements through troubleshooting complex maintenance issues.



Anritsu Site Master is Field Proven in the Most Extreme Environments

Overview

In 1995, Anritsu launched the world's first field portable cable and antenna analyzer in response to the explosion in installations of base stations to support the global mobile phone industry. The Site Master quickly established itself as the essential instrument for field engineers building cellular networks. Since that first model launch, Anritsu has continuously enhanced and developed the Site Master to meet the requirements of a wide range of cellular, LMR, broadcast, and defense transmitter systems.

Today, Anritsu introduces the latest version of the Site Master, building on over 25 years experience in the market. The Site Master MS2089A has the accuracy, reliability and functionality you expect from Anritsu with new features including ReadyCal™ and faster sweeps to enhance your productivity in the field.

RF cable runs continue to be an integral part of radio communication base stations, from long runs on broadcast transmitter towers to short jumper cables on cellular base stations. With the large-scale deployment of Distributed Antennas Systems (DAS) in areas of high user density, the scale of RF cable installations continue to expand. Their exposure to weather and hostile environments mean cable runs represent the greatest single point of failure or system degradation in modern radio networks.

Whether performing a new site installation or maintaining an established site, the Site Master MS2089A provides the ultimate instrument for validating or fault finding RF cable and antenna installations.

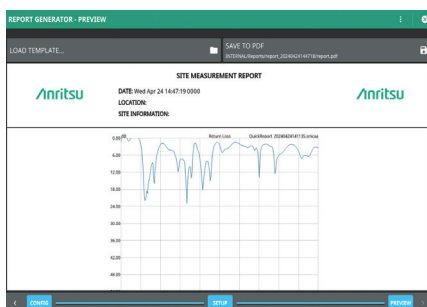

Report Generator Preview



Fast Sweeps



InstaCal™ ICN51A



Designed for Rugged Field Use

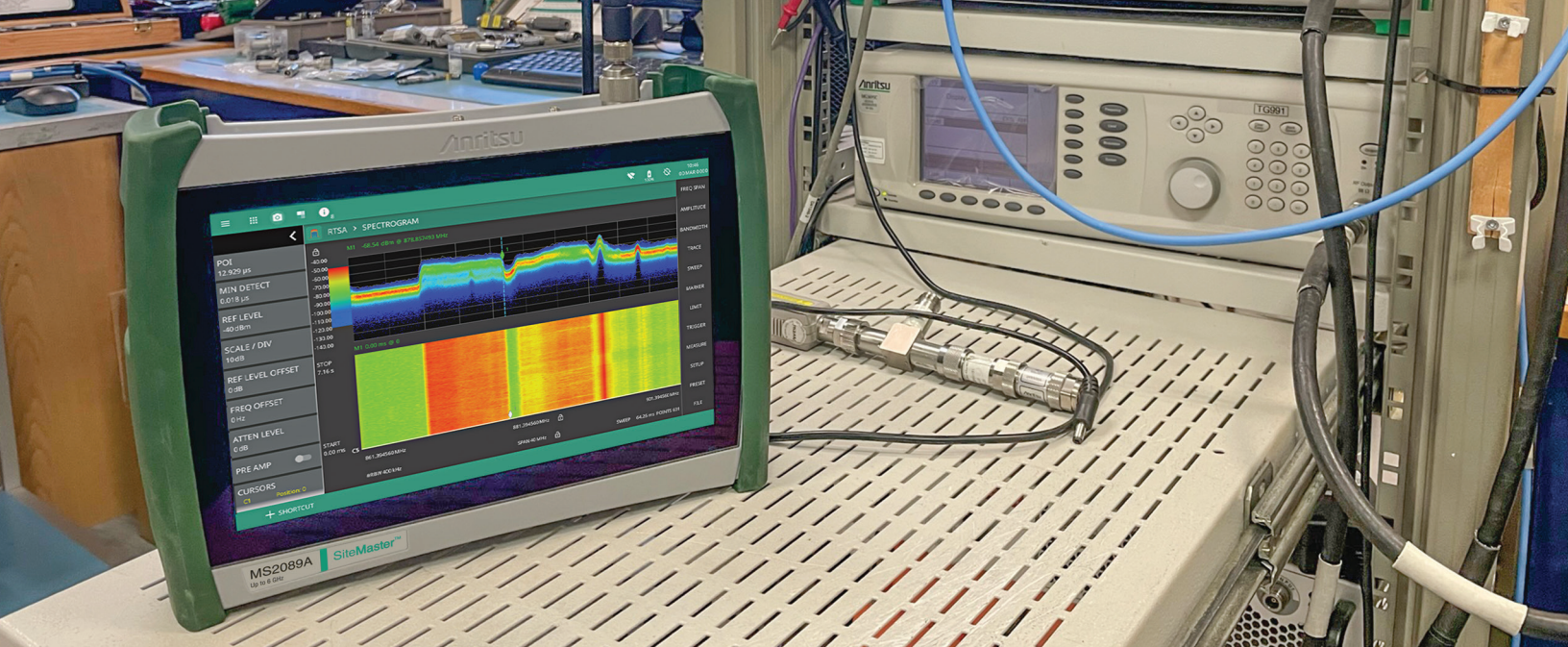

The RF Performance of the Site Master MS2089A Makes it Ideal for General Purpose Lab Applications

Designed for the Field

Transmitter towers are often located in remote locations where radio communications form a critical part of the communities infrastructure. Maintaining and repairing faulty sites demands reliable test instruments. The Anritsu Site Master has a hard won reputation for reliability and robustness even in the toughest of environments. All Site Masters are factory proven in extreme temperatures and demanding drop and vibration trials. We design the instruments so you can be confident of getting the job done, however extreme the location.

Weighing less than 4 kg, the Site Master is small, compact, and easy to carry. An optional shoulder harness attaches to the supplied soft case to ease long-term use outdoors, especially with over nine hours of continuous operation with the extended battery pack. An environmental rating of IP52 in the soft case protects the instrument from dust and water, ensuring it is always ready to make the measurements you need in the location you need them.

At Home in the Lab

For use on the bench, the hard case with rubberized easy grip bumpers and integrated kickstand make the Site Master MS2089A the ideal instrument for general purpose lab measurements where portability and space are at a premium.

Multifunctional Instrument

The Site Master MS2089A is a spectrum and cable and antenna analyzer that integrates RF field technician's most commonly used instruments into a single package. That means less for you to carry and a single user interface to learn, making your time in the field more productive. The applications available are:

- Spectrum Analyzer
- Real-Time Spectrum Analyzer (RTSA)
- Interference Analyzer
- AM/FM Modulation Measurements
- LTE FDD/TDD Analyzer
- 5GNR FR1 Analyzer
- Coverage Mapping
- Channel Scanner
- WCDMA FDD Analyzer
- Cable and Antenna Analyzer
- Return Loss
- Distance-to-Fault
- TDR (Ohm/Linear)
- 2-Port Transmission Measurement
- 1-Port Phase
- Cable Loss
- True Power Meter



Site Master MS2089A with Power Sensor, and Handheld InterferenceHunter™ MA2700A



Site Master MS2089A Delivers over Three Hours of Field Use with Built in Battery

Fully Featured Spectrum Analyzer

From HF military radio through 100 MHz broadcast FM, Land Mobile Radio at 400 MHz, and LTE and 5G cellular radio, the RF spectrum is becoming increasingly crowded. A spectrum analyzer is the primary instrument for field engineers to monitor, maintain, and optimize the performance of RF communications systems.

The Site Master MS2089A is designed with the requirements of RF field engineers in mind. Building on 20 years' experience developing handheld spectrum analyzers, the Site Master MS2089A brings together all of our knowledge into a portable and rugged instrument with a familiar multi-touch interface. The typical DANL with a built in preamplifier of < -165 dBm, coupled with a TOI of +14 dBm and typical level accuracy of ± 0.5 dB enable the full range of signals to be captured and displayed with confidence.



Measuring the Channel Power of an LTE Carrier between Adjacent Carriers

Common measurements are simplified with quick setups provided for Channel Power, Occupied Bandwidth, and Adjacent Channel Power.



Site Master™ MS2089A

Spectrum Analyzer Overview

Feature	Comment
Spectrum Analysis from 9 kHz to 4 GHz or 6 GHz	For coverage of common commercial RF communications bands
Spectrogram	To capture and record intermittent and drifting signals
RTSA	For real-time spectrum analysis with 2.5 μ s POI
AM/FM Modulation Measurements	AM/FM modulation quality, audio output, audio spectrum and audio oscilloscope
Channel Scanner	Measures the power of multiple transmitted signals
Smart Measurements	Includes channel power, occupied bandwidth, adjacent channel power, spectral emissions, C/I, and field strength measurements
Spectrum Record and Playback	To record traces and play back at slow speed to track all spectrum activity
USB Power Sensor Support	For precision power measurements of transmitters
Cable and Antenna Analyzer	For RF cable and antenna testing at transmitter sites
Zero Span	For pulse measurements
Quasi-Peak Detector	For CISPR compliant interference measurements
Interference Hunting	With directional antenna and eCompass handle
Cellular Measurements	5GNR FR1, WCDMA and LTE FDD/TDD transmitter measurement suites
10-Inch, Multi-Touch Display	Provides quick and easy configuration and results presentation
GNSS	GPS, Galileo, GLONASS, BeiDou
Report Generation	Integrated PDF/HTML report generator for trace files, photographs and screen images

Key Specifications

Performance	
Sweep Speed	32 GHz/s, 45 GHz/s with Option 102
Phase Noise	-97 dBc/Hz @ 1 GHz freq and 100 kHz offset (typical)
DANL	< -167 dBm (with preamp On, typical)
Residual Spurious	< -120 dBm, preamp On
Maximum Input Signal	+30 dBm
Damage Level	5 Watts
Frequency Accuracy	Aging: $\pm 1.0 \times 10^{-6}$ per year accuracy: $\pm 2.8 \times 10^{-7}$ (-10 °C ± 55 °C) plus aging
Amplitude Accuracy	± 1 dB (± 0.5 dB typical)
Resolution Bandwidth in Sweep Mode	1 Hz to 5 MHz
Resolution Bandwidth in Zero Span	1 Hz to 20 MHz with Option 102
RTSA Bandwidth	20 MHz standard, 40 MHz with Option 102

Spectrum Analyzer Measurements

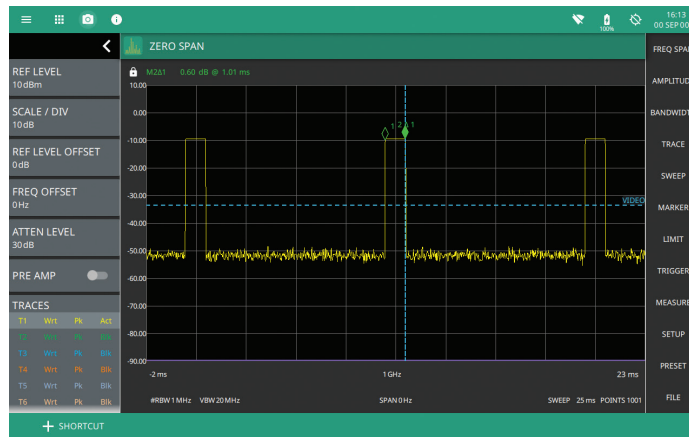

Use Zero Span to View Radar Pulses and TDD Transmitters

Analyze pulsed or TDD signals in real time using up to 40 MHz zero span analysis bandwidth with 20 MHz RBW. Coupled with a 60 ns minimum sweep time Site Master MS2089A allows viewing of pulses as narrow as 50 ns. This enables analysis of all common pulsed radar and TDD communications systems.



Multi-Trace, Multi-Marker Features

Display up to six traces simultaneously with different detectors and averaging applied to each. Up to 12 markers are provided to highlight signals of interest and monitor how they vary over time, relative to themselves and other signals. Alerts for new interfering or lost signals are generated automatically with limit save on event functionality to optimize long-term monitoring of the spectrum.

Option 199 – Real-Time Spectrum Analyzer (RTSA)

The Site Master MS2089A features an optional RTSA with up to 40 MHz analysis bandwidth. Ideal for capturing short duration and digitally modulated signals that can be hard to identify in standard spectrum analyzer mode, the RTSA enhances the interference hunting capability of the Site Master MS2089A.

With a capture rate of 527,000 FFT/s, signals down to 2.5 μ s are displayed at full amplitude and down to 9 ns with reduced level accuracy. A spectrum density display uses color to maintain and present users with greater insight of the RF spectrum activity by maintaining the image of spectral occupancy over time. It is even possible to identify low power signals that would otherwise be masked by higher power signals in the spectral density view.

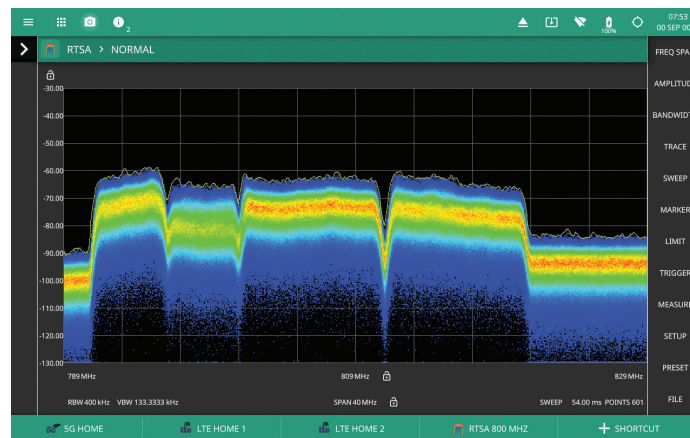

Multiple LTE Carriers Viewed with the RTSA

Open the spectrogram display to view a history of activity in the spectrum, capturing short lived and intermittent signals. For extended time monitoring and analysis, record traces to internal memory or to an external drive for later play back on the instrument or offline.



Interference Hunting

Radio frequency communications are central to many aspects of our modern life. In addition to our personal smartphone communication needs, health care monitors, logistics tracking, first responders, and smart factories have all become dependent on reliable radio communications networks. As demand for radio spectrum expands, the chances of interference from unintended or illegal sources grow. To ensure reliability of service, owners of RF communications networks and devices need tools to help identify, locate, and mitigate against interference.

The Site Master MS2089A has been designed to provide an array of features to support field technicians in detecting and locating interfering signals. Because interference originates from many sources, multiple tools are required to complete the task.

Up to 45 GHz/s sweep speed in standard spectrum analyzer mode (with Option 102), coupled with a spectrogram display, maximizes the probability of seeing short duration or TDD interferers. Switching to an RTSA mode when the frequency of the interferer has been validated ensures detection of the shortest interfering burst, or even signals below the power level of the wanted carrier that can still downgrade system performance.

For regulators, evaluating the impact of pulsed or TDD interfering signals, the Site Master MS2089A Quasi Peak detector provides CISPR 16-1-1 compliant measurements of all signals identified with markers.

Option 24 – Interference Finder

Option 24 includes AM/FM audio demodulation of interfering signals, interference hunting tone for direction finding, and geolocation of interferers on a digital map. When the interfering signal has been identified, AM/FM audio demodulation provides greater insight into the possible cause. Speech or music on the signal indicates an illegal transmitter or intermodulation with other networks. Noise or clicks may suggest heavy industrial machinery that is not suppressed, or cables insecurely attached to transmitter towers.

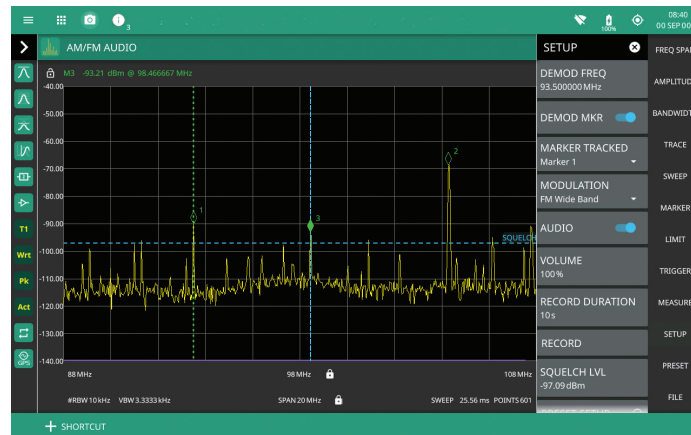

AM/FM Signal Demodulation at Marker Frequency

The interference hunting tone outputs a variable frequency tone that increases in pitch as the signal strength increases. When used in conjunction with a directional antenna, this facilitates the precise location of signals of interest. When coupled with the InterferenceHunter MA2700A handle and directional antenna, the Site Master MS2089A provides interference mapping for geolocation of the signal. The InterferenceHunter™ MA2700A includes an eCompass, which indicates the direction it is pointing on a digital map downloaded onto the instrument screen. Rotating through 360 degrees builds a polar plot of signals from all directions at your current position.

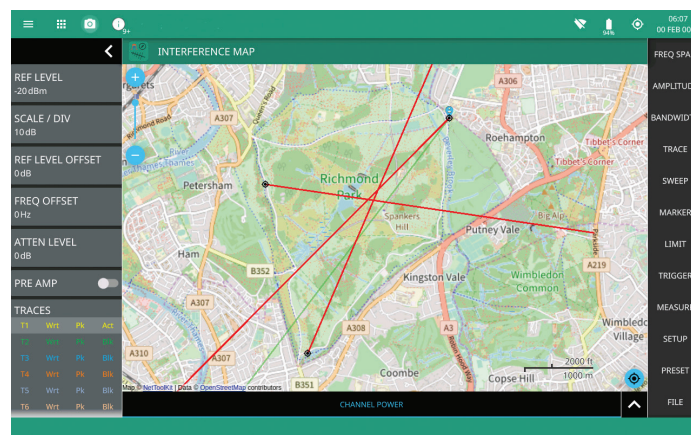

Map Triangulation



PIM Hunting

With widespread use of rooftop sites for location of cellular base stations, passive intermodulation has become a major source of interference in base station receivers. Metallic objects on the rooftop, including common items such as air conditioning units, guard rails, and fastening bolts can act as generators of RF intermodulation products when in the line of site of transmitters. The 2000-1884-R PIM Hunter™ accessory is designed to pinpoint the origin of PIM on a rooftop. The probe tip detects PIM when in close proximity to a PIM source. When used with the audio tone of the Site Master MS2089A, this facilitates the rapid sweeping of a rooftop to locate all PIM sources.

Option 444 – EMF Measurements

Option 444 uses the spectrum analyzer sweep and a tri-axial isotropic antenna to measure field strength in frequency-specific bands in all spatial directions. This is useful for both LTE and 5G FR1 to ensure radios are not transmitting excessive power. Three antennas are supported, providing frequency coverage from 9 kHz up to 6 GHz. Antennas are individually calibrated and the instrument reads the calibration data through the USB interface. The same interface is used to switch rapidly between the three antennas orientations to provide complete three-axis isotropic measurements. The Site Master MS2089A displays the results of each axis on the spectrum display and a table presents a summary of measurements including peak and average field strength and measurement time. The total measurement time and axis dwell time and limits are user settable or can be defaulted to ICNIRP values.



EMF Results Show Power from each Antenna Axis and Summary Results for Peak and Average Power over a Defined Time Period



AM/FM Modulation Measurements (Option 509)

AM/FM Modulation Measurement (Option 509) adds a comprehensive AM/FM modulation quality measurement suite to support national regulators and AM and FM transmitter owners. Broadcast and LMR channels are becoming increasingly crowded driving a need to perform regular measurements on transmitters to confirm they are not over deviating or interfering with adjacent carriers in a very crowded spectrum. A single screen displays the RF spectrum, the audio frequency spectrum, the demodulated audio in oscilloscope format, and numeric results for key parameters. All these results are updated in parallel providing the best possible real time view of the AM or FM transmitter performance.



The AM/FM Modulation Measurements Screen Provides a Unique Simultaneous Display of Results and RF and Audio Spectrum

For broadcast FM, the audio spectrum trace highlights the mono audio, stereo pilot, left-right stereo channels and RDS sub carrier. At the same time, an audio oscilloscope displays the demodulated voice or music and the RF spectrum trace shows channel occupancy. This captures all the essential transmitter information on a single screen to provide the best possible overview of transmitter performance.

Integrated software routines calculate the essential audio quality measurements of AM depth and FM deviation. SINAD and THD are measured automatically when modulating the transmitter with a fixed frequency tone, typically 1 kHz. Use the built in speaker to listen to demodulated audio continuously and in real time at even as traces are updated.

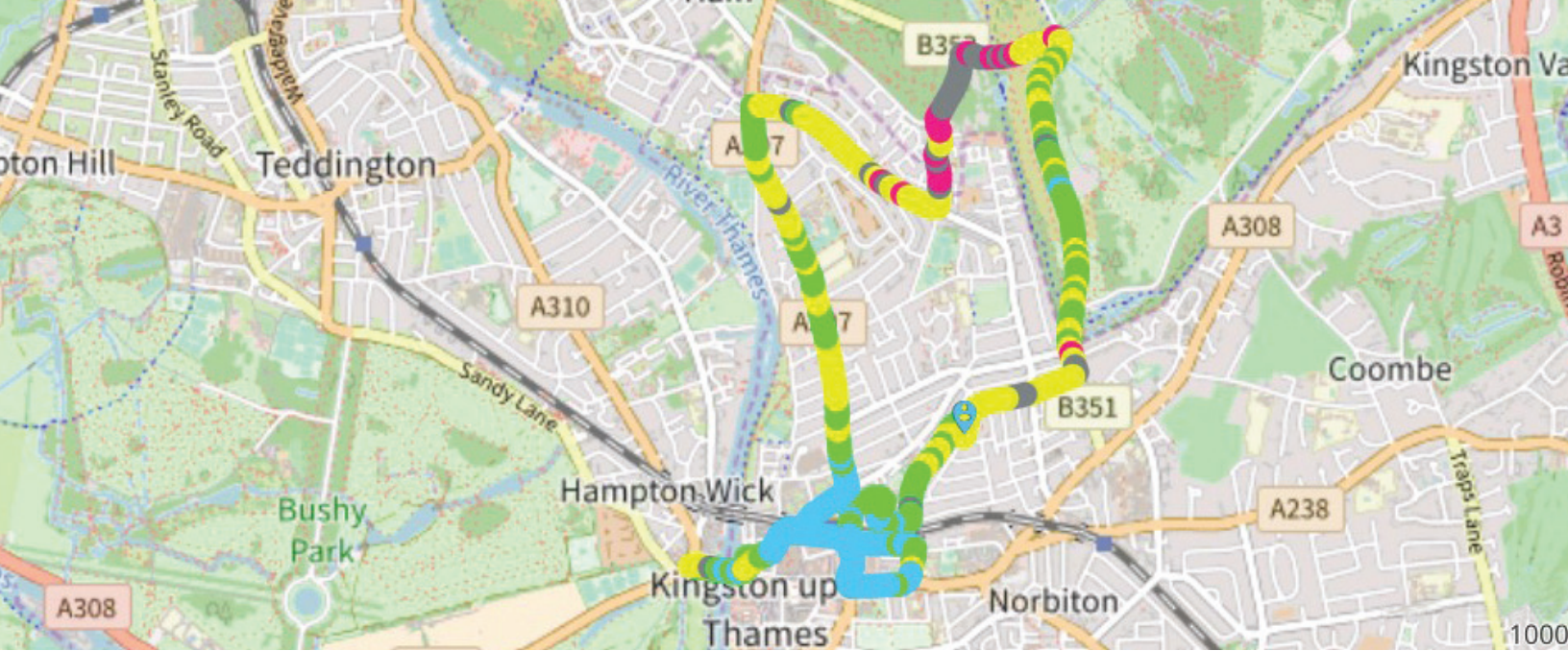

Option 431 – Coverage Mapping

As well as measuring the performance of the 5G and LTE base stations, operators need to understand the coverage that is being achieved from each sector at each cell site. Modeling predicts coverage, but changes in the real-world environment can result in areas with limited or no network coverage.

The Site Master MS2089A coverage mapping option plots colored “breadcrumbs” that represent the signal strength of the cellular signal at any given map data point. Maps are quickly downloaded directly from a web service into the instrument memory using the Wi-Fi or Ethernet interface, eliminating the need to create maps on a PC and transfer them by memory stick.

Signal coverage can be mapped based on a number of base station metrics; transmitter channel power, spectral density, and RSSI measurements or 5G/LTE signal quality RSRP/RSRQ/SINR results. When mapping based on 5G or LTE signal quality such as RSRP is selected, the results can be filtered for any individual PCI. This enables users to understand the coverage from specific antennas and specific base station masts.

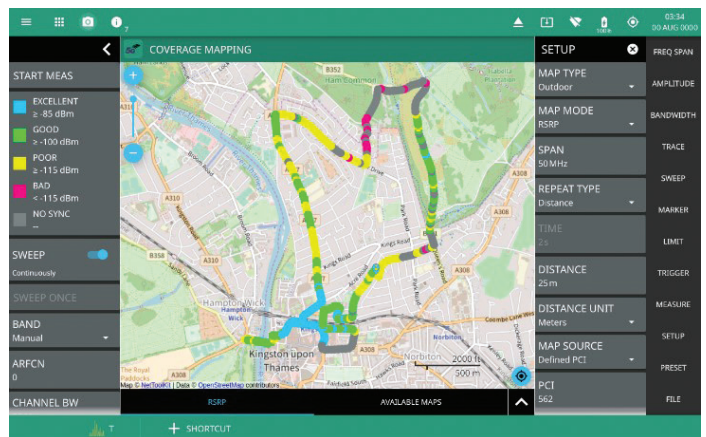
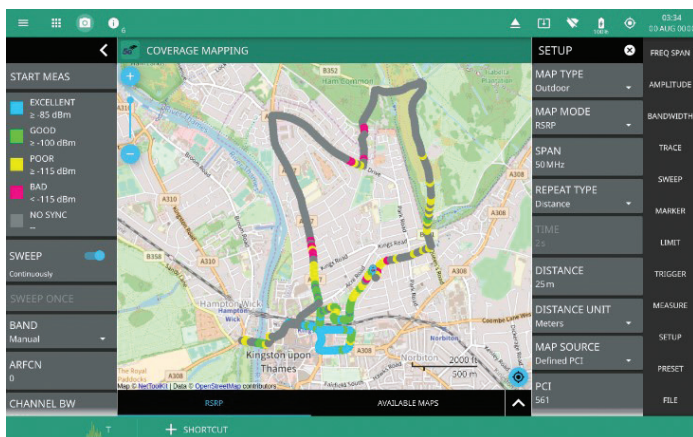

Following a Coverage Mapping Drive, Filter by Specific PCIs to See Coverage from Individual Base Stations or Antennas



5GNR and LTE Modulation Quality and Transmitter Measurements

From the first roll out of GSM networks in the 1980's through 3G and LTE, Anritsu has been at the forefront of providing instruments to enable the installation and maintenance of cellular networks. Now with the introduction of 5GNR networks, Anritsu remains at the leading edge of cellular network testing.

The Site Master MS2089A integrates all the essential instruments for 5G base station testing in the field into a single field portable instrument. Modulation quality, transmitter quality, coverage mapping, and RF cable and antenna line sweep measurements are all included. Simple mode switching between instruments provides a common user experience and results are saved to a single location to ease report generation.

Whether you are rolling out a new network as an operator or contractor, installing a private 5G network, providing network optimization, or confirming regulatory compliance, the Site Master MS2089A delivers the measurements and features you need to get the job done fast.

5GNR Downlink Measurements (Option 888)

Installing and maintaining 5G base stations require testing of signal quality and transmitter measurements. With the introduction of active antenna systems to create the beamforming signal patterns common to 5G base stations, the availability of test access connectors has reduced. Measurements are more commonly made over-the-air (OTA).

The Site Master MS2089A supports direct connect and OTA measurements of 5G base stations. When testing OTA, the Site Master MS2089A may see signals from multiple base stations at different locations. In this case, the results are clearly identified by each individual physical cell ID (PCI) and the relative performance and time of arrival are displayed on the results screen.

For signal quality measurements, the Site Master MS2089A identifies the location of the synchronization signal block (SSB) which is used as the basis of all signal quality measurements. For FR1 5G signals, the SSB has a bandwidth of 3.6 MHz for subcarrier spacing of 15 kHz and 7.2 MHz for subcarrier spacing of 30 kHz.

Summary of 5G Downlink Signal Quality Measurements		
PCI Cell, Sector ID, Cell Group	SS-RSRP/RSRQ/SINR/RSSI	Time Offset
Frequency Error	Modulation Quality (SS-EVM)	Difference in Time Offset
Beam ID	PBCH Constellation	OTA Multi PCI Scanner
Channel Power	Occupied Bandwidth	Carrier Aggregation (eight carriers)
Adjacent Channel Power (ACP)	Spectral Emissions Mask (SEM)	Coverage Mapping
LTE/5G	TDD Uplink Interference with Gated Spectrum	

Use the standard spectrum analyzer mode for basic transmitter quality measurements or 5G mode for time gated measurements focused on the SSB.

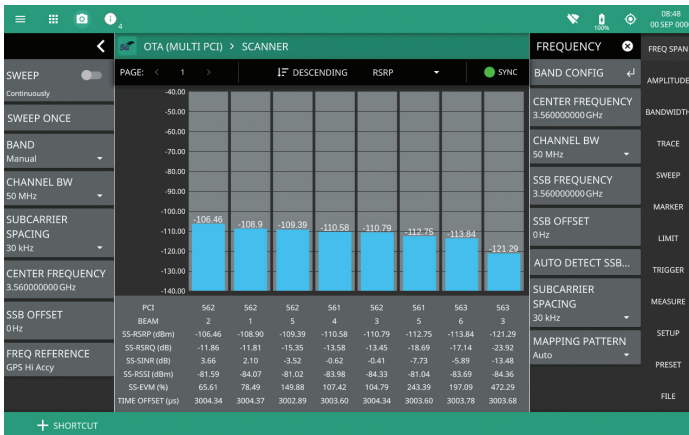

5G OTA Results

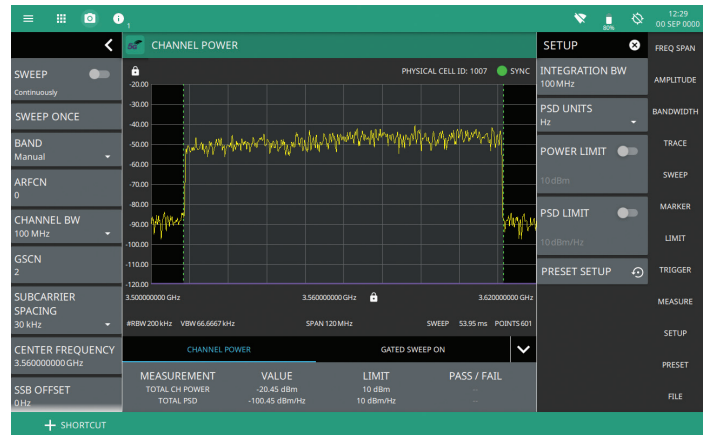

5G Channel Power Results in 5G Mode

The Site Master MS2089A has many advanced features to simplify the testing of 5G base stations. An autodetect SSB capability searches across the 5G frame to identify the location and offset of the SSB element if it is unknown. The carrier aggregation mode displays results for up to eight carriers on a single screen. Carrier aggregation is often used to increase the capacity of any given operator using distributed frequency spectrum. The single results screen summarizes the overall network performance in a convenient format.

National regulating authorities often require a measurement of EIRP to validate that total transmitted power is within statutory requirements. The Site Master MS2089A EIRP measurement corrects for signal path loss, antenna gain, and summing of vertical and horizontal powers to deliver a 3GPP compliant result.

Option 883 – LTE FDD/TDD Measurements

LTE remains at the heart of many national cellular networks and often provides the signaling control plane for 5G non-standalone (NSA) networks. Field technicians require a test instrument that includes 5G and LTE measurements.

The Site Master MS2089A includes a full suite of LTE signal quality and transmitter measurements. OTA and direct connect test methods are supported with OTA results showing all detected PCIs from available base stations.

LTE Overall Capability		
FDD and TDD Network Support	MIMO Antenna Power	MIMO Time Alignment
Resource Block Usage	Carrier Aggregation (eight carriers)	Multi PCI Scanner
Adjacent Channel Power (ACP)	Spectral Emissions Mask (SEM)	Control Channel Measurements
Constellation Diagrams for PBCH and PDSCH		
LTE Signal Measurements		
Cell ID, Sector ID, Cell Group	Frequency Error	Time Offset
PBCH, RS and SS Power	TDD UL/DL Interference	PBCH
PDSCH EVM (all modulation formats)	Time Alignment Error	OFDM Symbol Transmit Power
LTE Transmitter Measurements		
Channel Power	Channel Spectrum	Coverage Mapping

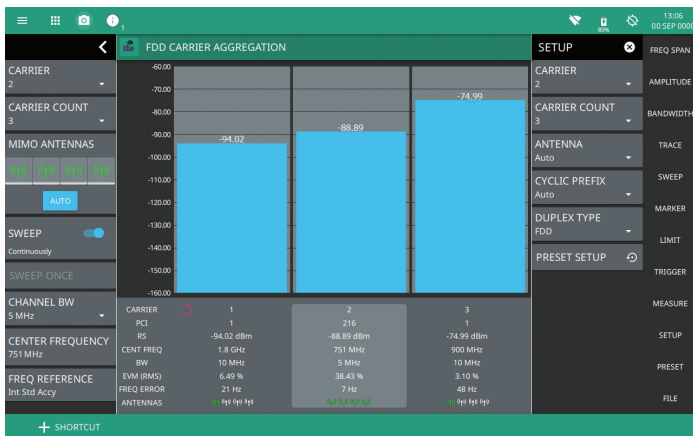

Use Carrier Aggregation Mode for Over-the-Air (OTA) Capture of Multiple LTE Signals

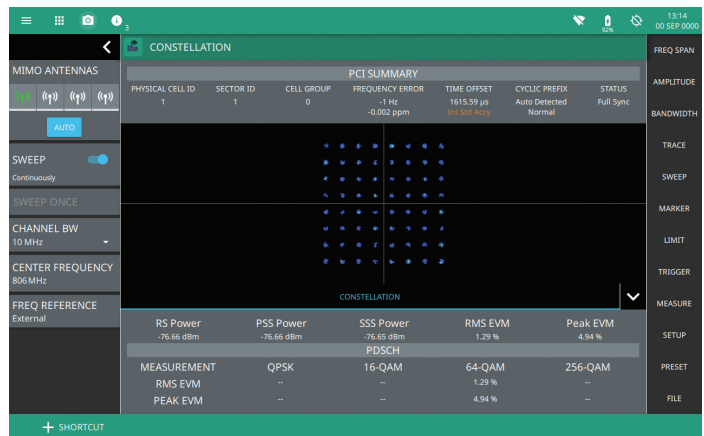

LTE Modulation Quality EVM Measurement on PBCH and PDSCH

Dynamic Spectrum Sharing (DSS) Detection in LTE Frames

Many cellular network operators have chosen to update their LTE base stations to support limited 5G capability using a technique known as DSS. If an LTE base station is updated to enable DSS mode, part of the LTE frame is allocated to 5G signals. This embeds a 5G SSB into the LTE frame. The DSS capability is limited to the 20 MHz bandwidth offered by the LTE standard.

By using DSS technology, network operators can provide 5G capability to subscribers without installing new 5G gNB base stations.

The Site Master MS2089A is able to perform LTE and 5G modulation quality measurements on DSS signals. In LTE mode a DSS detect feature automatically identifies if a 5G SSB is present in the LTE frame and therefore can validate if a frame is standard LTE or if it contains DSS capability. This allows operators to confirm that LTE base stations have successfully updated from standard LTE to DSS capable.

Option 871 WCDMA FDD Base Station Measurements

Network operators with legacy 3GPP WCDMA networks continue to need field maintenance instruments. The WCDMA base station measurement option includes the essential measurements required for base station maintenance. This provides field engineers a single test instrument that supports the most common technologies in a network. WCDMA measurements supported include:

- Occupied Bandwidth
- Spectral Emission Mask
- Channel Power
- Adjacent Channel Power
- Carrier Frequency
- Frequency Error
- Scrambling Code

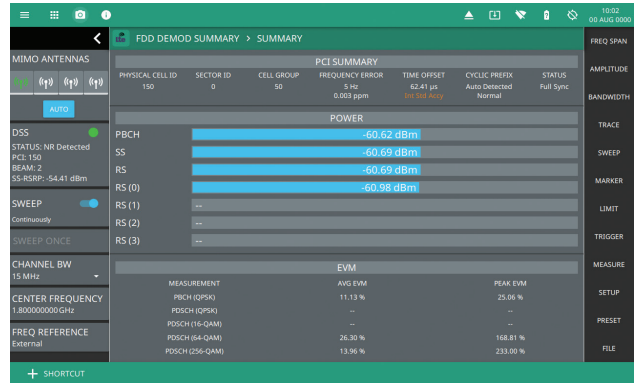

LTE Results Summary with DSS Detection Result Displayed in the Status Panel

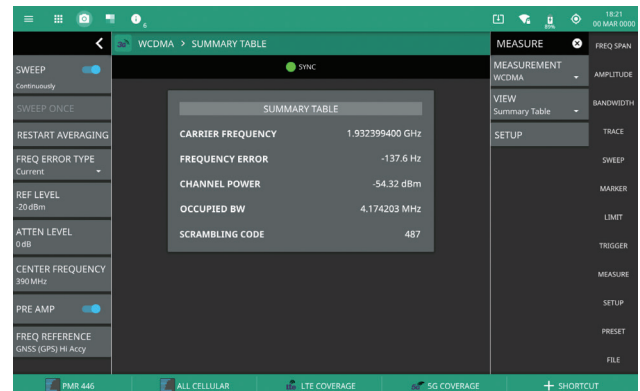

WCDMA Summary Table



MIH Vehicle Setup with Magnetic Mount Omni Antenna on Roof of Truck

Mobile InterferenceHunter™ MX280007A

Anritsu's Mobile InterferenceHunter (MIH) MX280007A software is a field proven application for identifying the location of interfering signals over a wide area. Mobile interference hunting is achieved by applying proprietary algorithms to channel power data captured with geolocation positioning information during an area drive in a vehicle. MIH can distinguish between multiple signal sources, reflections, RF shadows, drifting signals, bursty signals, and multi-path transmitters, making it a cost effective solution for a wide range of interferers.

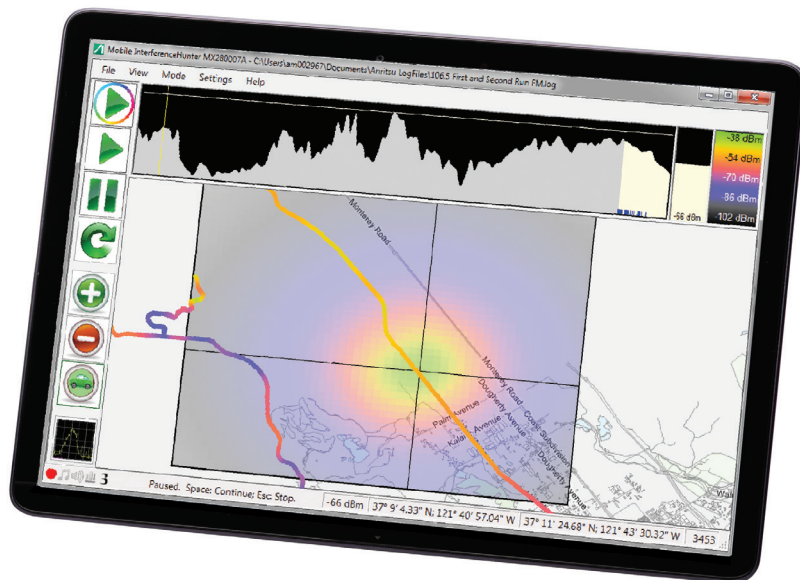

*OpenStreetMap® Displayed on a Windows PC Tablet.
InterferenceHunter Screen Capture. Dots Shown along Drive
Path are Colored According to Signal Strength.*

Option 400 Vision™ Monitor Option 407 Vision High Speed Port Scanner (Options 4xx Enable Vision PC software)

Vision Monitor software offers a range of applications for monitoring the RF spectrum over a period of time and storing results to a database. Vision Monitor is an ideal tool for long-term interference monitoring. Limits can be set with automated alarms for limit violations to capture short-term or intermittent signals. Other features include a scanner option that enables the monitoring of a range of frequency bands or channels over time with unique settings for each channel being monitored. A multi-trace view shows the spectrum for all channels being monitored on the same display.

The Vision Monitor application is fully automated. Measurements can be captured and periodically uploaded to a database for further processing. Depending on need and storage capacity, users can store spectrum history over many months or years with a user-defined capture assigned schedule.

All spectrum measurement databases are searchable, allowing the user to quickly locate patterns of signal activity relevant to an investigation. The spectrum history can also potentially be used in legal proceedings for documenting illegal or unlicensed broadcast activity. Other functions provided by Vision Monitor include:

- Threshold and trace mask settings for alarm generation
- Email alert sent when threshold violation generates an alarm
- Reporting on spectrum integrity on a daily or weekly basis
- Vision runs on a PC/laptop using the Windows® operating system

The high speed port scanner option maximizes the capability of the Site Master MS2089A spectrum analyzer by configuring multiple channels for high speed sequential monitoring. This facilitates the monitoring of multiple radio spectrum channels, such as satellite downlinks, TETRA, P25 or broadcast FM for activity and conformance with a single instrument.

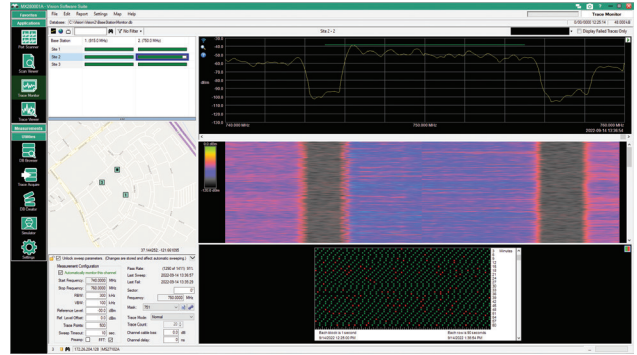

Vision Monitor Simultaneously Displays Current Spectrum, Spectrogram, and Pass/Fail History over an Extended Time Period on a Single Screen

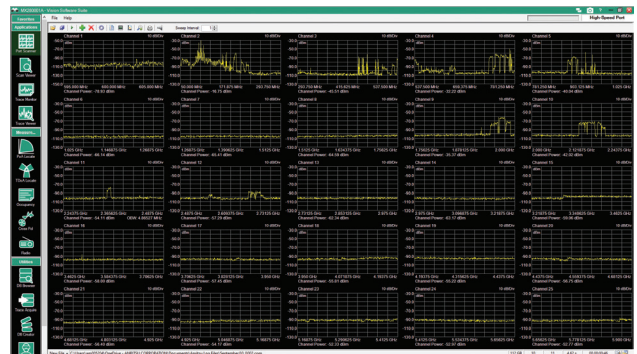

Use the High Speed Port Scanner Monitor Multiple RF Channels with a Single Site Master MS2089A on a Single PC Monitor

Option 128 Vector Signal Analysis

The IQ Signal Master MX280005A PC software is designed to perform physical layer modulation analysis of common communication transmitter signals. When Option 128 is enabled on the Site Master MS2089A, the IQ files captured are signed, facilitating their post processing and analysis using the MX280005A PC software. During the design and manufacturing stages of a wireless communication system, it is common to measure the modulation quality with benchtop instruments. Using the IQ capture option of the Site Master MS2089A together with the MX280005A software, these measurements can be validated in a field environment.

Framed and unframed signals are supported. In framed mode, the software decodes common wireless signals including public safety (TETRA, P25, DMR) to aerospace and satellite communications. In unframed mode, the software analyzes continuous modulation such as DQPSK, QAM, ASK, and FSK. The Site Master MS2089A supports IQ captures up to 40 MHz bandwidth, meaning narrowband communications signals or wideband satellite downlink signals can be captured and analyzed with the same application.

MX280005A software can initiate the capture of IQ data from a Site Master MS2089A over an Ethernet connection or a data capture can be triggered manually through the Site Master MS2089A touchscreen. Multiple analysis formats are provided including signal spectrum, EVM, constellation diagrams, eye diagrams, and numeric result tables. A comprehensive insight into all aspects of the transmitter performance is provided as multiple results windows can be displayed simultaneously.

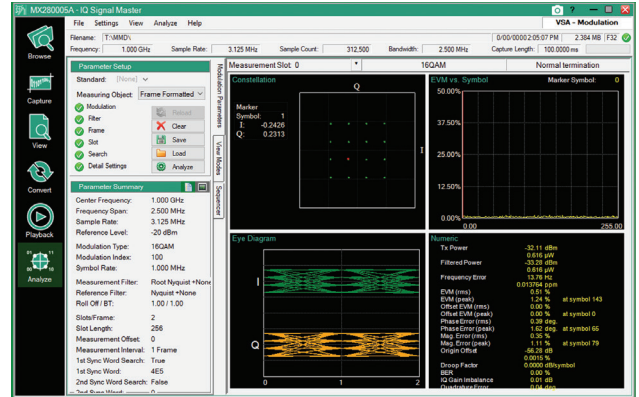

MX280005A Single Screen Multiple Results Vector Signal Modulation Windows



Built-in Cable and Antenna Analyzer

The Site Master MS2085A/MS2089A is built for base station tower RF cable and antenna feed measurements. The Site Master is available in two frequency ranges, 5 kHz to 4 GHz that covers the common PMR and cellular bands and the 5 kHz to 6 GHz model covers all of the 5G NR FR1 band. The CAA user interface was developed using over 20 years experience of line sweeping measurements in the field. The Site Master delivers the fastest sweep speeds in a field portable instrument, making it ideal when searching for faults and monitoring results traces while tapping connectors and cable clamps. A dual measurement display shows return loss and distance-to-fault (DTF) on a single screen.

The insertion loss of long cables is measured with the addition of a USB power sensor or directly with the 2-port option. When using a power sensor for transmission measurements, USB extension leads of up to 100 meters in length enable accurate cable loss measurements to be completed without removing the cable from its installation. Calibration is achieved with traditional OPEN/SHORT/LOAD calibration accessories, using the new InstaCal one-step calibration module, or when quick results are required, the factory ReadyCal provides instant access to measurements. All common cable performance data is stored in memory and generation of close out reports is simplified with file formats that can be read into Anritsu's industry leading remote reporting tool PC application for results processing.

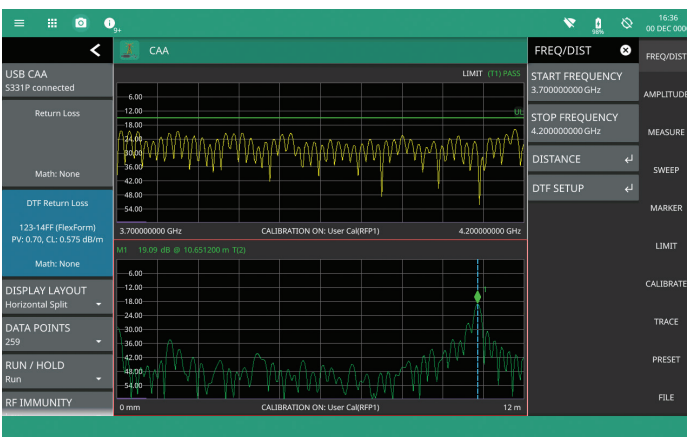

Simultaneous Display of Cable and Antenna Return Loss and Distance-to-Fault (DTF)

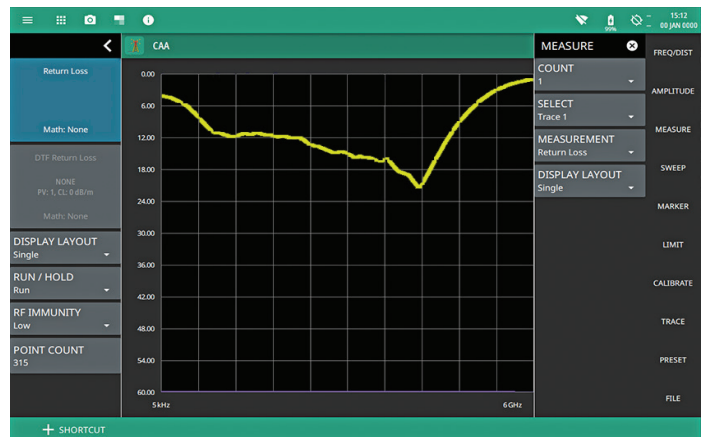

CAA Return Loss

Cable and Antenna Analyzer Overview

Feature	Comment
Reflection Measurements	Return Loss VSWR Cable Loss 1-Port Phase Smith Chart
Transmission Measurements	Transmission (USB Sensor) 2-Port Transmission Measurement (Option 21)
Distance-to-fault (DTF) Measurements	DTF Return Loss DTF VSWR
Time Domain Reflectometry (TDR) (Option 3)	TDR Ohm TDR Linear
High Accuracy Power Meter (Option 19)	Support for USB power sensors for measurement of transmitter power
Filter Measurements (with Option 21)	Validation of frequency response and rejection of bandpass and notch filters
Biasing of Tower Mount Amplifiers	Bias voltage for accessory bias tee to test with in line TMAs
Comprehensive Calibration Options	ReadyCal for immediate results with factory data Standard Open/Short/Load user calibration InstaCal accessory for automated calibration
Split Screen Display	For simultaneous Return Loss and DTF view or DTF and TDR view
Anritsu Remote and Report Tools (ARRT) PC Post Processing Application	For report generation and data analysis
RF Cable List	Built in library of the characteristics of the most common transmitter site cables
Integrated GNSS Module	Site locations verified when creating close out reports
Environmentally Hardened	Built to withstand the demands of an instrument designed for use in challenging environments
10-Inch, High-Resolution, Multi-Touch Screen	Displays all results on a large clear display with easy-to-use multi touch interface

Key Specifications

Performance	
Output Power	High: 0 dBm, typical Low: -40 dBm, typical
Measurement Accuracy	Corrected Directivity: >44 dB typical, OSL Calibration >40 dB typical, InstaCal Calibration
Fast Sweep Speed	< 350 μ s per data point for faster results and better response
Frequency Accuracy	\pm 2.5 ppm (-10 $^{\circ}$ C to 55 $^{\circ}$ C) plus aging, typical Aging: \pm 1.0 x 10 ⁻⁶ per year
Battery Life	nine hours operation ¹
¹ CAA with internal battery • 5 hours operation, typical, CAA with an accessory battery • 9 hours operation, typical SPA with internal battery • 3 hours operation, typical, SPA with an accessory battery • 6 hours operation, typical	

Cable and Antenna Analyzer Measurements

Measuring the performance of the radio network RF cable and antenna feeds is essential to the efficient performance of a network. During the installation phase, kinks in the cable, or poorly assembled connectors will result in signal loss or reflection. The signal loss in long cable runs limits transmitter efficiency meaning that installation engineers always need to verify cable and antenna insertion loss and return loss.

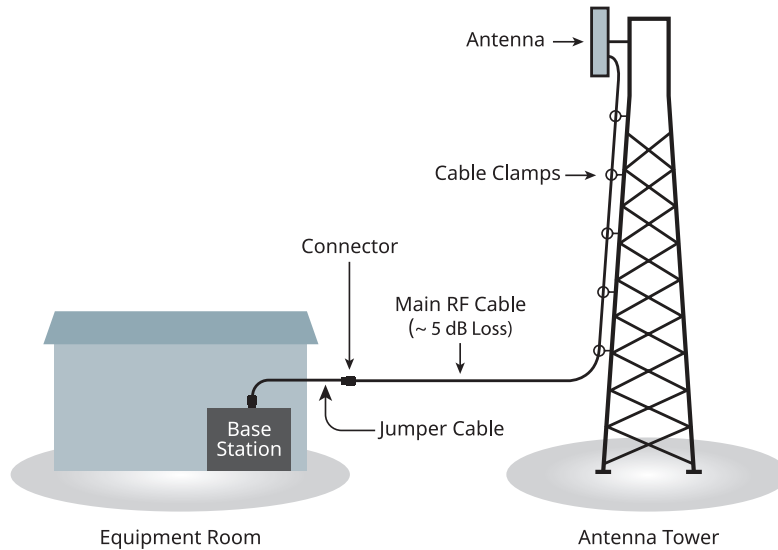

The new Site Master MS2085A builds on over 25 years experience testing cables and antennas in the field. With a Site Master MS2085A, you can be sure of getting the job done quickly, efficiently, and with confidence in the quality of the results.

Return Loss and Distance-to-Fault Measurements

Return loss and voltage standing wave ratio (VSWR) are the fundamental measurements for testing cable and antenna feeds. The Site Master MS2085A clearly displays these measurements on its large, high-resolution, 10-inch screen, with limit lines and markers readily accessible for testing against site requirements. While return loss is the best measurement to verify the health of a system, distance-to-fault (DTF) is used to troubleshoot systems and locate the problem. The Site Master MS2085A DTF measurement uses a fast Fourier transform to convert frequency data to the time domain and displays signal reflections with respect to distance. Using the standard trace math feature, you can monitor small relative changes over time.

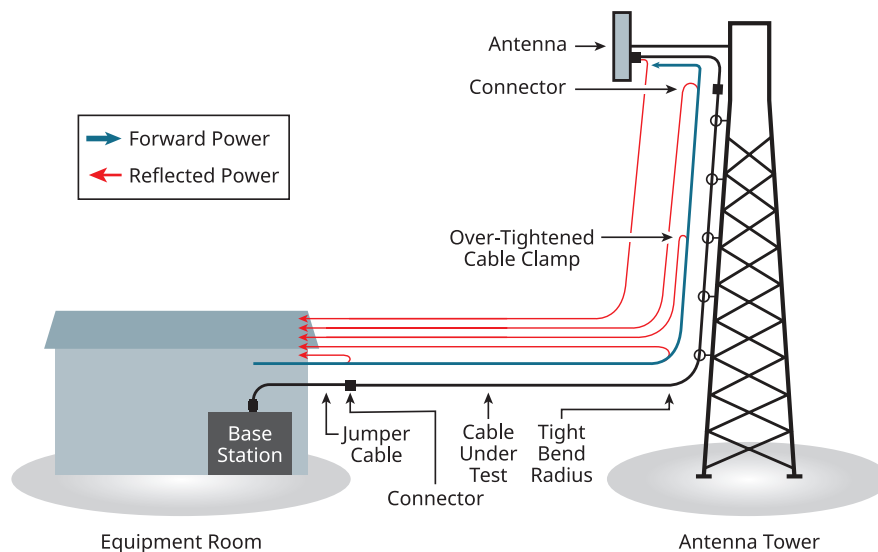

A split screen display of return loss and DTF pinpoints the position along the RF cable where the highest reflections are taking place while also showing overall return loss. This simplifies identifying the connector or cable clamp causing the issue hence speeding up the resolution of the fault.



Split Screen Showing Return Loss and DTF Return Loss of a 20 Meter Cable Feed

Time Domain Reflectometry (TDR) Option 3 to Complement DTF

When a return loss measurement identifies a cable and antenna path that do not meet specification, it is necessary to locate the cause of the reflection and initiate a repair. A basic DTF measurement quickly locates the distance of the individual reflections from the input test port. For long cable runs such as those found in DAS systems or running up high transmitter towers, the more information that is known about the cause of the reflection, the quicker and easier the repair becomes.

A TDR measurement shows impedance against distance, with a normal 50 ohm line running across the center of the display. Different causes of reflections such as open circuits, short circuits, kinks to the outer cable conductor and water ingress will cause characteristic changes to the transmission line impedance. This in turn helps identify the cause of the fault and accelerates the repair process.

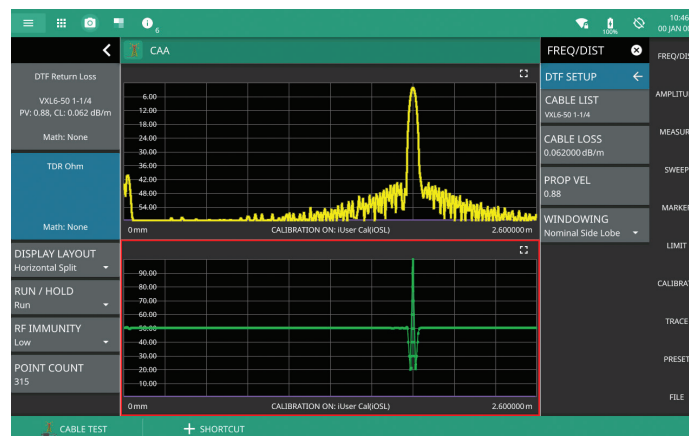

Split Screen Showing DTF and TDR Measurements

Insertion Loss Measurements

Macro transmitter sites can exceed 100 meters in height. RF cable feeds between the base station and antenna on the tower requires low loss cables to ensure minimizing signal loss in. Measurement of cable insertion loss after a cable has been installed requires access to both ends of the cable. The Site Master MS2085A offers three techniques to measure the insertion loss of cables.

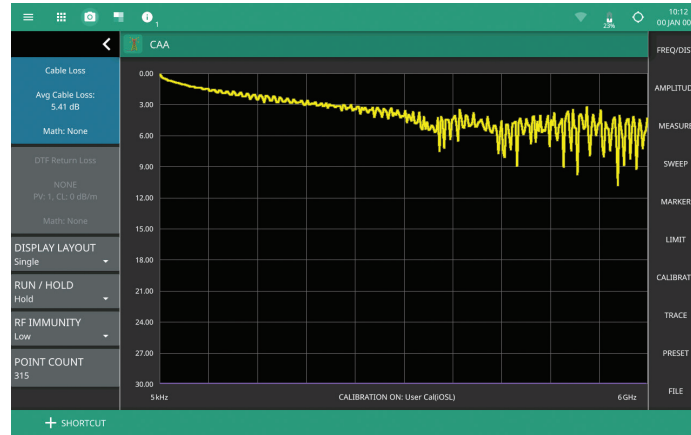

Single Ended Insertion Loss Measurement of an 18-Meter Cable Run Highlighting Increased Loss with Frequency

Single ended insertion loss measurements. This technique requires an OSL calibration at the instrument test port. The cable under test is then connected to the test port and the far end of the cable is left open circuit which results in full reflection of the power. The Site Master MS2085A calculates and displays the insertion loss over frequency based on the level of reflected power received. This technique is ideal when the two ends of the cable are far apart and total insertion loss is <20 dB.

Insertion loss with external USB power sensor. This technique requires the user to be able to connect a USB power sensor to the far end of the cable under test. The level at the input to the cable under test is used as a reference level. Anritsu power sensors support USB cable lengths up to 5 meters, or to over 20 meters with accessory extender kits.

Insertion loss using the Site Master MS2085A receiver port 2 (requires Option 21). This technique uses the receiver port of the Site Master MS2085A to measure power loss through a cable. The technique offers the best dynamic range, but both ends of the cable under test must be connected to the instrument which makes it unsuitable for cables already installed up a tower. Pre-installation tests on cable drums are most suited to this technique.

DAS System Measurements

Distributed Antenna (DAS) systems are widely deployed to provide comprehensive radio network coverage inside buildings such as transport hubs and sports stadiums. An extensive network of combiners, RF cable runs, splitters and antennas provide signal coverage over multiple floors and distances of hundreds of meters. A typical DAS networks includes hundreds of individual RF cables, splitters and antennas. To ensure expected network coverage, it is essential that all cables and components meet their design specification for loss and reflection.

Anritsu Site Master is the ideal instrument to test and document the performance of all DAS system components during the installation process. A Quick Name keyboard setting saves time and reduces filename errors when saving result traces. The Favorites cable list provides easy access to the parameters of multiple cables that may be included in a DAS. Complimentary Report Tool PC application facilitates the creation of the detailed close out reports typically required for site sign off.

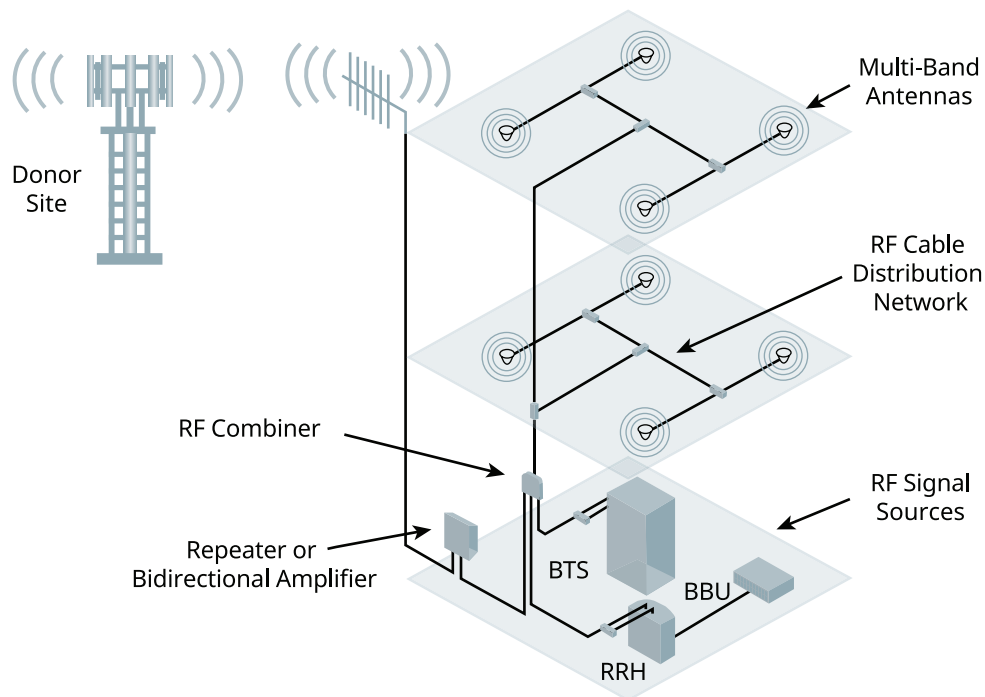

DAS Systems Contain Multiple Cables and Components Enhancing the Need for Detailed Line Sweep Measurements at Both the Component and System Level

2-Port Measurements with Option 21

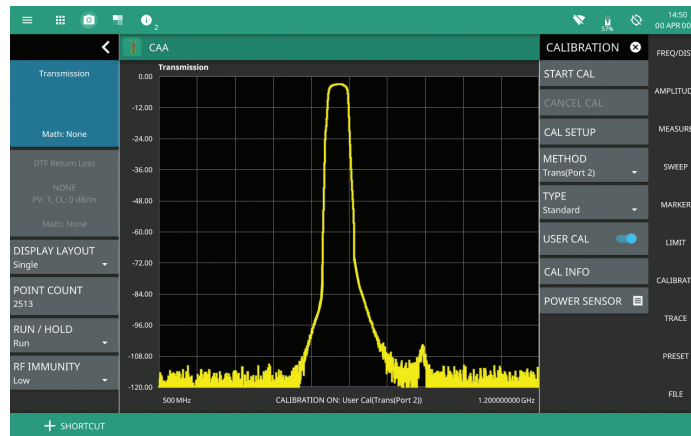

Band Pass Filter Measurement with 100 dB Rejection

Cellular base stations today use diplexers, duplexers, and tower mounted amplifiers to extend the coverage area and reduce interference. The Site Master MS2085A series 2-port transmission measurement enables you to make gain, isolation, and insertion loss measurements as well as verify sector-to-sector isolation.

The second port is a selective receiver which provides up to 100 dB dynamic range which makes it possible to test the band pass filters common on many networks.

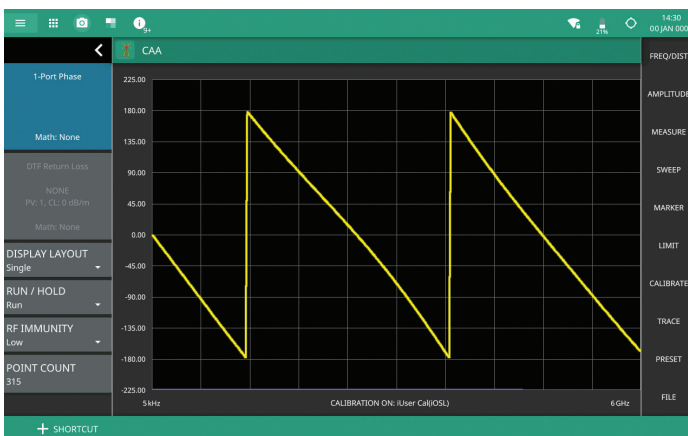

1-Port Phase Measurements

When installing jumper cables between the radio unit and antenna, it is often necessary to phase match the lengths of all the cables. The 1-port phase measurement and trace math features facilitate this task to ensure consistent length of all cables.

RF Immunity Setting

When testing antenna return loss over-the-air (OTA) the antenna under test may be subject to RF signals from nearby transmitters as well as the test signal itself. The Site Master MA20xxA series proprietary RF immunity algorithm enables you to make accurate cable and antenna measurements even in the presence of strong RF activity from co-located cell sites.

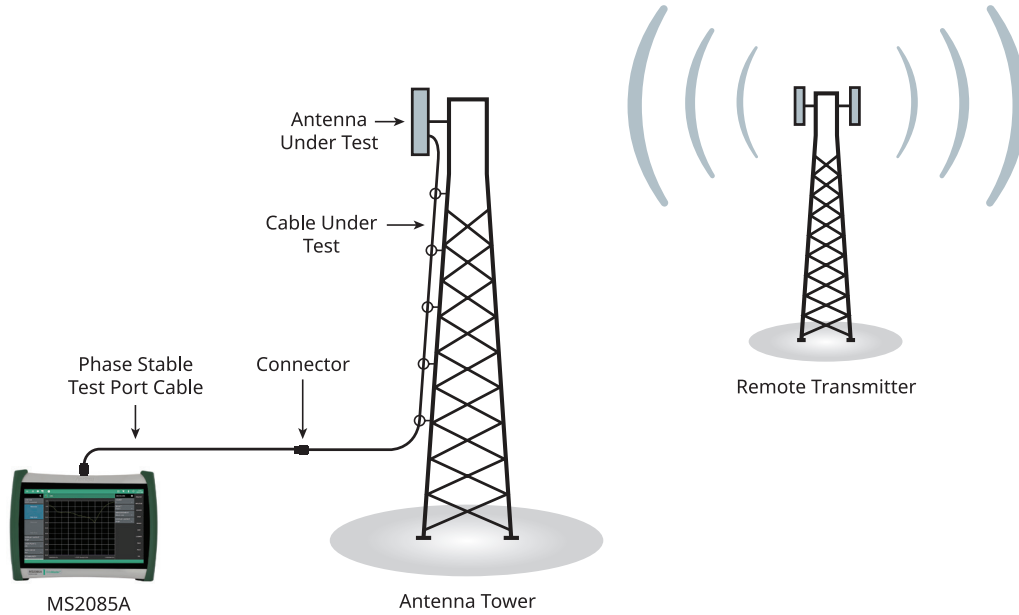

MS2085A RF Immunity Feature Enables OTA Measurements in the Presence of External Interferers

Bias Tee Support

Some radio networks deploy tower mounted amplifiers (TMA) to boost the receiver sensitivity. These amplifiers are located close to the receiver antenna and often difficult to access from the ground. Their inclusion in the system adds complexity to the test process. TMAs inhibit return loss measurements through to the antenna and their gain needs to be measured. TMAs are powered by a bias voltage and this requires the test instrument to support a bias tee when testing systems deploying them. The Site Master MS2085A includes a bias voltage output to put between +1 and +34 Volts on the center conductor of the bias tee accessory to enable testing of radio systems with TMAs.

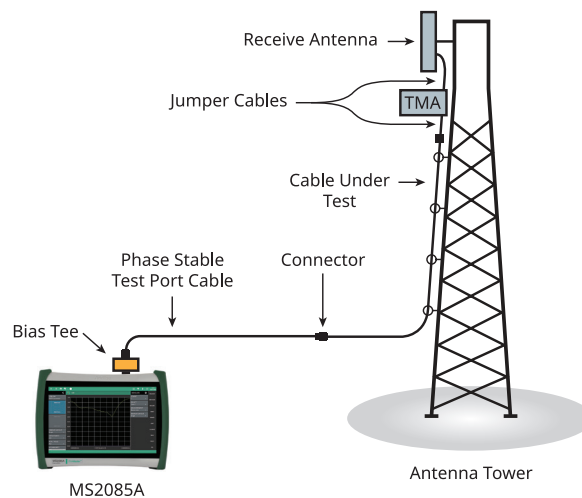

Use of a Bias Tee Enables Measurements on Systems that Deploy a Tower Mount Antenna Close to the Antenna at the Top of a Mast

Comprehensive Calibration Options



Site Master with InstaCal and OSL Cal Kit OSLN50-8A

ReadyCal. Where speed of test is important and measurements are being made in a controlled temperature environment, the ReadyCal feature uses factory calibration data for return loss measurements. Use of ReadyCal eliminates the need to perform user calibrations or recalibrate when changing the frequency range. When making measurements around room temperature, the accuracy is comparable to that achieved with user calibrations.

Open/Short/Load. Anritsu offers a range of OSL calibration pieces covering different frequency ranges and test port connector standards. When performing a OSL calibration routine, the on-screen wizard guides the user through the process eliminating calibration errors.

InstaCal. The InstaCal accessory provides the fastest and most convenient user calibration process. A single connection to the test port is followed by the automated switching of an open, short and load to the test port under USB control. Each InstaCal is factory calibrated and the calibration data is downloaded over the USB interface to optimize resulting measurement accuracy.

Ease of Use Built on 25 Years Experience

To enhance productivity, the Anritsu Site Master MS2085A integrates decades of experience gained from making cable and antenna analyzer measurements in the field. Comprehensive marker features and limit lines aid pass/fail testing to document compliance to specifications. Guided calibration routines ensure no errors during the calibration process. Multiple trace views in the same window with trace math to compare results facilitate the tracking of performance changes and degradation. A distance-to-fault configuration aid plus the most complete cable data base ensures the DTF measurement are always optimized for distance accuracy, speed and resolution.

By selecting the Anritsu Site Master, you are choosing quality and experience.

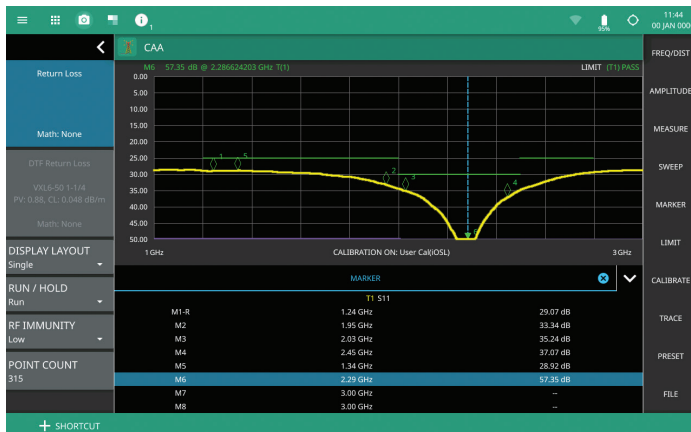

Comprehensive Limit Lines and Markers

Highlight points of interest of return loss and DTF traces with up to eight markers. Automated marker to Peak and Valley keys simplify positioning markers with all marker results are presented in a clear to read table.

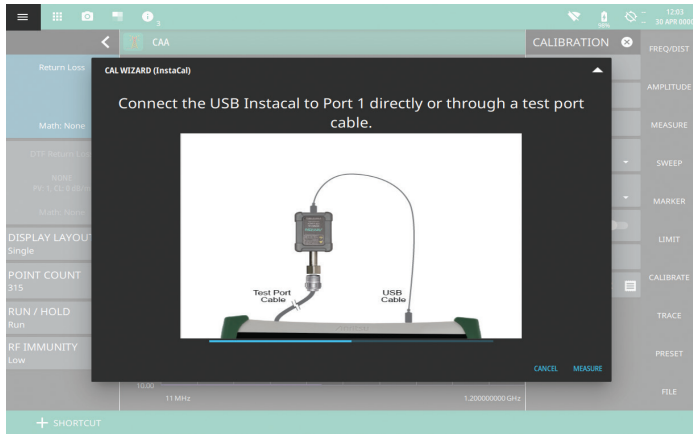

Calibration Wizards

Reliable calibration is assured by the use of calibration wizards that guide users through the calibration process ensuring the correct calibration items and processes are followed.

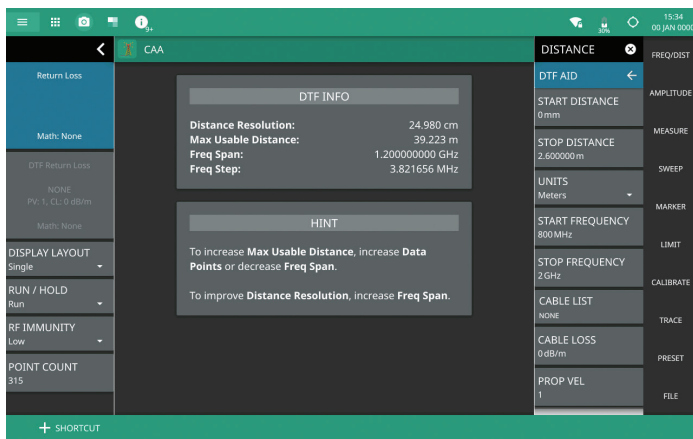

DTF Aid Simplifies Configurations

A built in DTF aid helps users optimize the frequency sweep to get the best and most accurate distance range and resolution, ensuring faults are found quickly and reliably.

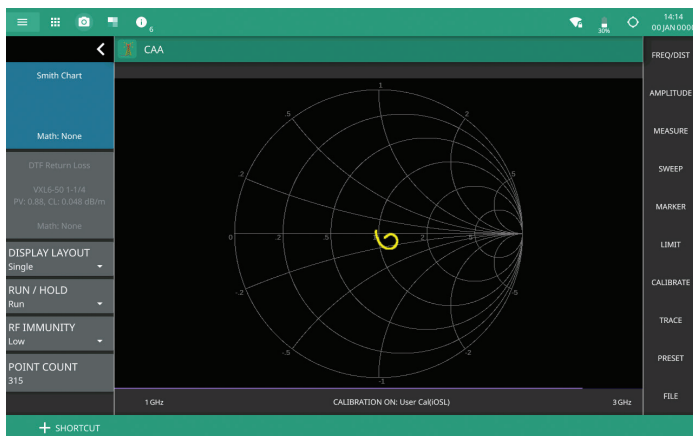

Built-in Smith Chart

Smith charts are used to give a quick visual overview of transmission line and antenna impedances. Inductive and capacitive changes along the transmission line are highlighted by deviation from the center of the graph.

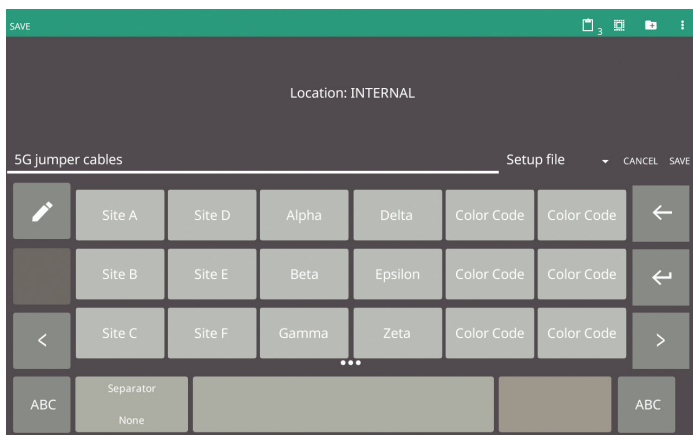

Fast File Naming

New transmitter base stations or DAS installation will require the testing of multiple cables, each requiring testing and documenting. The EZ keyboard makes the job of file naming fast and consistent, which makes it easier to review the test plan and ensure all cables have been tested.

Anritsu Remote and Report Tools (ARRT) PC Application

Anritsu Remote and Report Tools (ARRT) is a freely downloadable software application to enable post processing of line sweep traces and report generation using a PC. When manipulating files from a large DAS installation the total number of result traces can extend to the hundreds. The use of an ARRT when managing large projects is preferred to the built in report generator.

Remote Tool

The Anritsu Remote Tool provides remote access to a network connected instrument and displays the same user interface, instrument controls, and live measurement data on the computer screen. The software also allows you to load measurement and setup data from saved files and then perform measurement analysis on the recalled traces, even when instrument hardware is not available or is not connected to the PC by using the simulation. Further analysis and report generation can be performed on the Anritsu Remote and Report Tools.

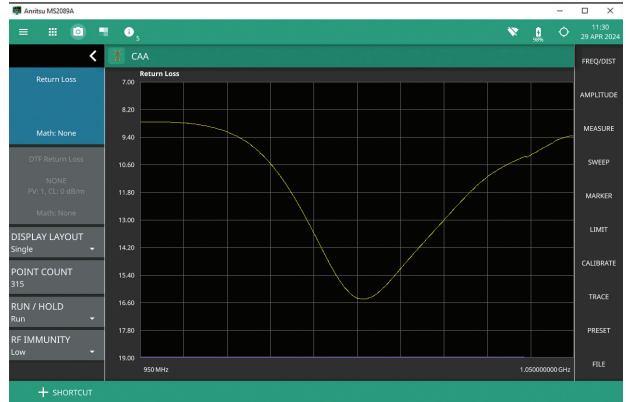

Anritsu Remote Tool

Report Tool

Transferring traces to the PC is facilitated by a file management system for rapid and confident selection of all work completed on site. Once the traces have been imported to the PC, use ARRT to position markers and limit lines on traces captured during the work session. The traces can be arranged into their preferred order and a comprehensive close out report created in .pdf format for submission to the prime contractor.



Anritsu Report Tool

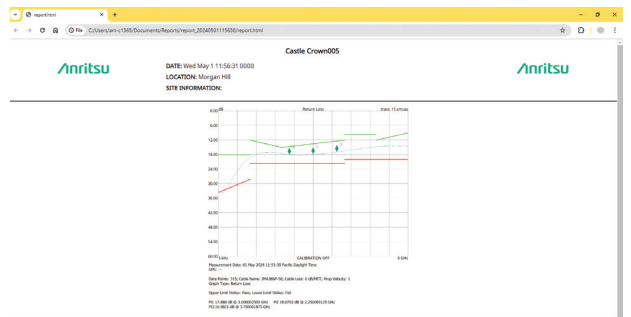

Report Preview

Certified Training Courses



Classroom Setting

Anritsu is committed to providing the best introduction to cable and antenna measurements possible. We offer web-based cable and antenna training and face-to-face instructor-led training. Instructor-led courses provide theory and practical instruction on line sweep measurements when installing RF cables and antennas in the field. The instructor-led courses include the option of an end-of-course test which qualifies successful students to receive an "Anritsu Line Sweep Certified" certificate. Proof of line sweep certification is a requirement of many operators globally for contract field engineers to work on their networks.

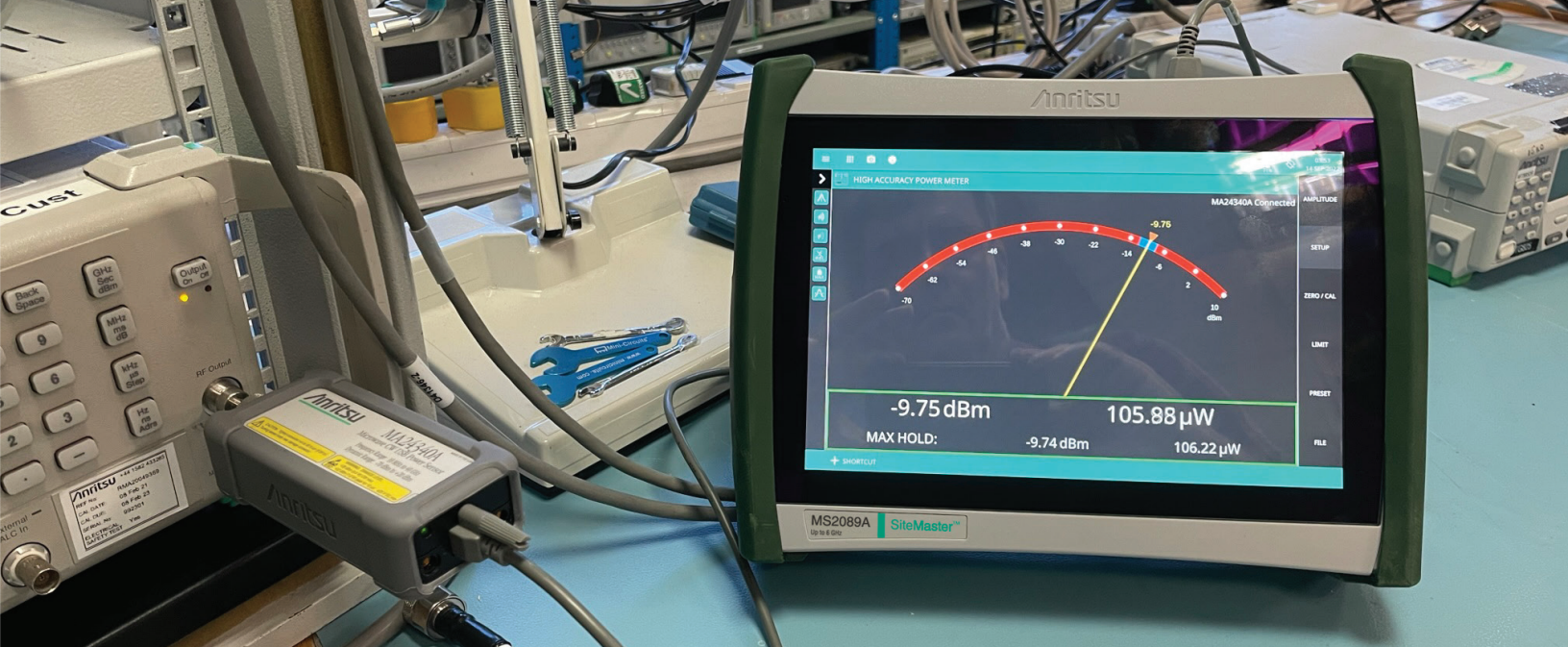

Site Master MS2085A/89A Supports Integration with USB Power Sensors for Maximum Measurement Accuracy

Option 19 – High Accuracy Power Meter

The Site Master MS2085A/89A delivers power meter accuracy power measurements when coupled with Anritsu's USB power sensors. Connect a supported USB sensor directly to any of the Site Master MS2085A/89A USB ports.

- Microwave CW Power Sensors: MA24330A/MA24340A/MA24350A
- Universal Power Sensors: MA24208A/MA24218A
- RF CW Power Sensors: MA24108A/MA24118A/MA24126A
- Average Power Sensor: MA24106A

When using the Site Master MS2085A/89A to install a new cellular or LMR base station, it is important to set the transmitter power precisely. Too much transmit power can result in interference with other transmitters or adjacent cells, and too little power results in reduced cell site coverage. Option 19 provides a traditional analog power meter display with a fast-responding needle and complimentary digital read out. Limit lines with audible alarms aide testing to defined specifications and a Max Hold feature is ideal when tuning for maximum power. Select the MA241xxA series sensors for RF, CW, and MA243x0A series sensors for microwave CW measurements. The MA242xxA power sensors have a cascaded diode architecture to enable accurate power measurements on modulated signals. All USB sensors are powered over the USB cable so no additional batteries are required.

10-Inch, Multi-Touch Screen; Dual Display, Easy to Read

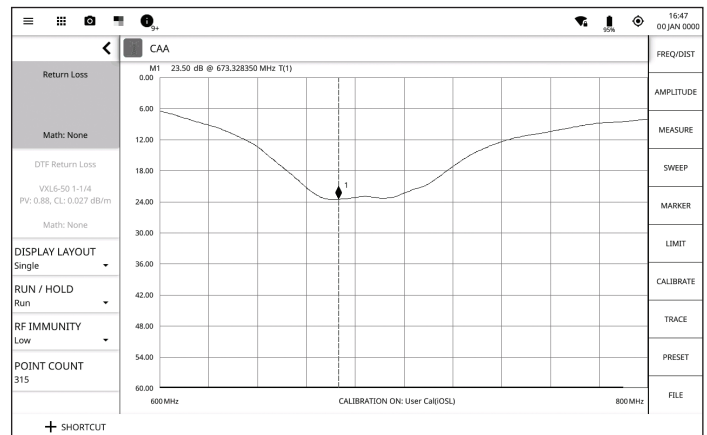
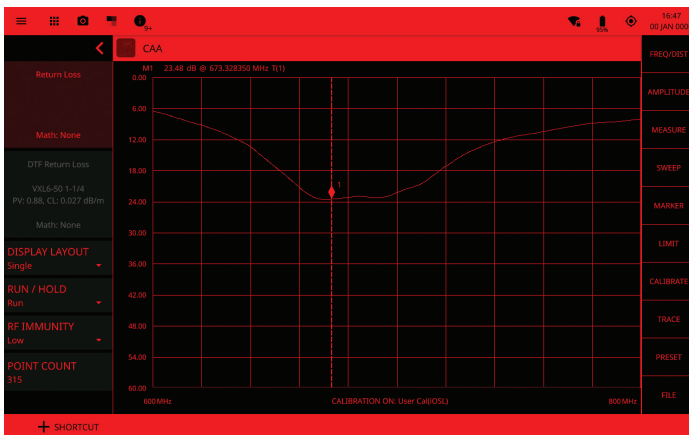
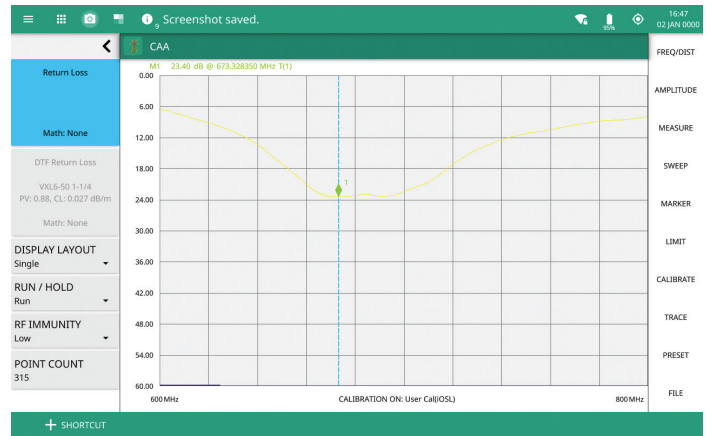
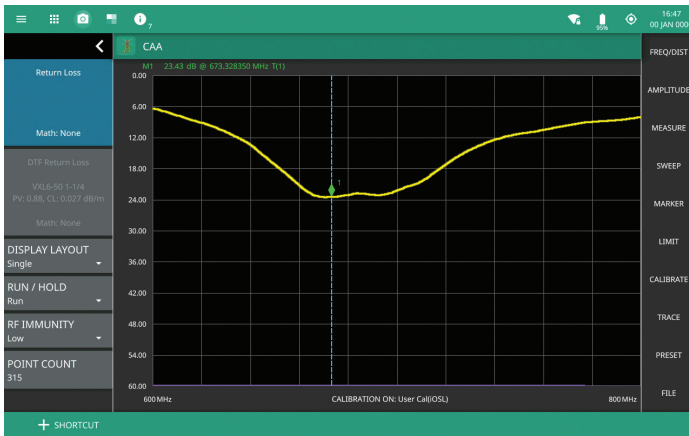

Switch between Four Different Display Themes to Optimize Viewing in Any Lighting Environment, from Direct Sunlight to Darkened Rooms

The large 10-inch, high resolution, multi-touch screen presents all the configuration and results information clearly and concisely. For outdoor use in direct sunlight, select the high contrast or black & white modes, or the Night Vision mode for use in dark or secure environments. A splash cover is offered for use in light rain, and when used in a cold environment the screen responds to standard touch screen gloves.

To protect from accidental damage due to the knocks and drops encountered in the field, the touch screen meets the requirements of the IK08 standard which requires resilience to direct impact from sharp and heavy objects.

Built-in Report Generator

Field technicians installing or testing base stations typically need to create a “Close Out” report to confirm all tests have been completed and passed limits. Base station installations generate multiple trace results and the creation of the report can be time consuming. The Site Master MS2085A includes a comprehensive built in report generator that simplifies this process.

The reports are created using a Report Generator tool. Reports can include any combination of trace files (typically cable and antenna analyzer traces), screen captures (to include spectrum and 5G results), and photographs (taken on a smartphone and transferred to the instruments file memory). Each report is user configurable to include essential site information such as GPS location, site name and contractor name. A company logo can be added to further customize the report. Once completed, the report is saved as a PDF and HTML file, for printing or distributing by email.

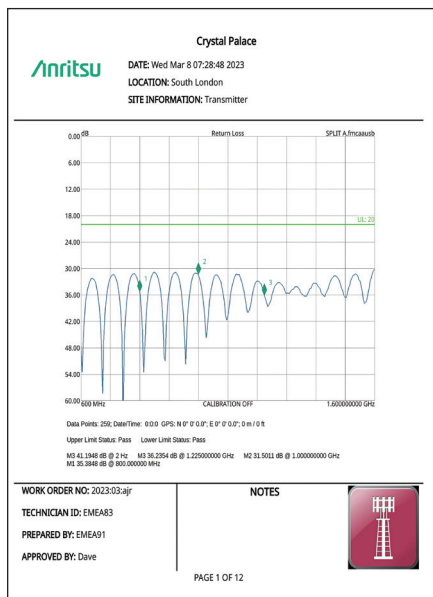

Trace Files



Photographs

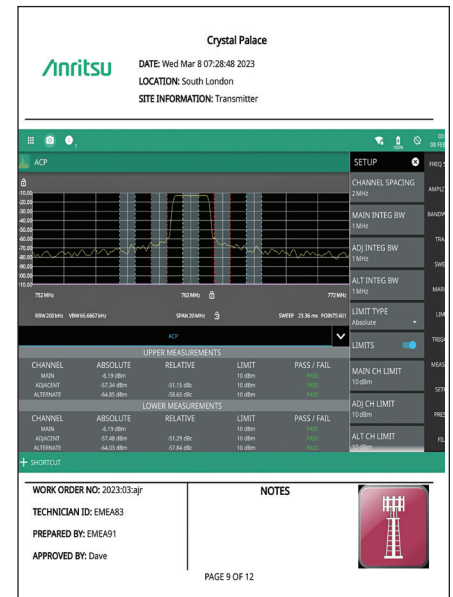

Screen Captures



Laptop PC Running Remote GUI Application with Wi-Fi Connection to MS2085A/89A

Remote Control and Connectivity

Ethernet, Wi-Fi, and USBTMC interfaces are standard on the Site Master, providing flexible options for remote control. Use Wi-Fi 802.11b/g/a/n to connect to wireless routers for common applications, including downloading digital maps and automatic software updates. A built in web browser enables internet access, necessary when public Wi-Fi hotspots require browser based network authentication. The USBTMC interface is ideal for controlling the Site Master from an Android smartphone, tablet, or PC.

Standard SCPI commands provide a familiar programming language for users who plan to write their own test programs.

The Anritsu Remote and Report Tool is a freely downloadable PC application that offers a remote user interface and report generation tools. Users can take full control of the Site Master from any remote location using this PC application. The GUI replicates the instrument touchscreen on a standard PC and can be used for remote instrument control and results and trace monitoring. The tool enables saving of traces directly to the PC file system where markers and limit lines can be added and adjusted retrospectively.

Flexible Charging Options

The built-in battery provides over three hours of run time. For extended operation in the field, the optional accessory power pack fits into the soft case pocket to extend run time to over six hours.



Site Master MS2089A with Standard Battery and AC Charger Plus Accessory Power Pack

Anritsu supports Site Master MS208xA users with a comprehensive range of accessories. The Site Master MS208xA comes with a standard rechargeable battery that delivers over four hours of continuous use in CAA mode. An AC power charger is standard and for powering and recharging.

A full range of calibration accessories and phase stable test port cables are also available.

Site Master MS208xA RF test ports are all N Type (f). Adaptors are offered for users working with other connector standards.

Site Master MS2089A Ordering Information

Part Number

Description

MS2089A

Site Master (requires Option 704 and 804 or 706 and 806)

MS2089A Site Master requires both a CAA and SPA option, which must be of the same frequency

Options

MS2089A-0804

Option 804, Cable & Antenna Analyzer, 5 kHz to 4 GHz

MS2089A-0806

Option 806, Cable & Antenna Analyzer, 5 kHz to 6 GHz

MS2089A-0704

Option 704, Spectrum Analyzer, 9 kHz to 4 GHz

MS2089A-0706

Option 706, Spectrum Analyzer, 9 kHz to 6 GHz

MS2089A-0003*

Option 3, Time Domain Reflectometry (TDR) Measurement

MS2089A-0017

Option 17, Secure Communications

MS2089A-0019*

Option 19, High Accuracy Power Meter (requires USB sensor, sold separately)

MS2089A-0021*

Option 21, 2-Port Transmission Measurement

MS2089A-0024*

Option 24, Interference Finder (Option 31 and directional antenna recommended, sold separately)

MS2089A-0027*

Option 27, Channel Scanner

MS2089A-0031*

Option 31, GNSS Receiver (requires GNSS antenna, sold separately)

MS2089A-0090*

Option 90, Gated Sweep

MS2089A-0102*

Option 102, 40 MHz Analysis Bandwidth

MS2089A-0126*

Option 126, IQ Waveform Capture (includes MX280005A IQ Signal Master base feature set)

MS2089A-0127*

Option 127, IQ Waveform Streaming (includes MX280005A IQ Signal Master base feature set) (requires Option 126)

MS2089A-0128*

Option 128, Vector Signal Analysis Enabled (requires Option 126)

MS2089A-0199*

Option 199, Real-Time Spectrum Analysis (RTSA)

MS2089A-0400*

Option 400, Vision Monitor Enabled

MS2089A-0407*

Option 407, Vision High-Speed Port Scanner Enabled

MS2089A-0431*

Option 431, Coverage Mapping (requires Option 31)

MS2089A-0444*

Option 444, EMF Measurement (requires Anritsu isotropic antenna, sold separately)

MS2089A-0509*

Option 509, AM/FM Modulation Measurements

MS2089A-0871*

Option 871, WCDMA FDD Measurements (requires Option 31)

MS2089A-0883*

Option 883, LTE FDD/TDD Measurements (requires Option 31)

MS2089A-0888*

Option 888, 5G NR Downlink Measurements (requires Option 31)

MS2089A-xxxx-0097

Accredited Calibration to ISO17025 and ANSI/NCSL Z540-1 (xxxx is the frequency option number)

MS2089A-xxxx-0098

Standard Calibration to ISO17025 and ANSI/NCSL Z540-1 (xxxx is the frequency option number)

MS2089A-xxxx-0099

Premium Calibration to ISO17025 and ANSI/NCSL Z540-1 plus test data (xxxx is the frequency option number)

*Time-Limited Options

Options marked with an asterisk are offered as a 90-day time limited option by ordering as a -9xxx series option. For example, MS2089A-9888 is the 90-day time limited option for 5G NR FDD/TDD Measurements. The option start time begins when the user first activates the option.

Supported PC Software

MX280001A

Vision™ Monitor

MX280005A

IQ Signal Master™

MX280007A

Mobile InterferenceHunter™

ARRT

Anritsu Remote and Report Tools

Site Master MS2085A Ordering Information

Part Number Description

MS2085A Site Master (requires Option 804 or 806)

Options

MS2085A-0804 Option 804, Cable & Antenna Analyzer, 5 kHz to 4 GHz

MS2085A-0806 Option 806, Cable & Antenna Analyzer, 5 kHz to 6 GHz

MS2085A-0003* Option 3, Time Domain Reflectometry (TDR) Measurement

MS2085A-0017 Option 17, Secure Communications

MS2085A-0019* Option 19, High Accuracy Power Meter (requires USB sensor, sold separately)

MS2085A-0021 Option 21, 2-Port Transmission Measurement

MS2085A-0031* Option 31, GNSS Receiver (requires GNSS antenna, sold separately)

MS2085A-xxxx-0097 Accredited Calibration to ISO17025 and ANSI/NCSL Z540-1
(xxxx is the frequency option number)

MS2085A-xxxx-0098 Standard Calibration to ISO17025 and ANSI/NCSL Z540-1
(xxxx is the frequency option number)

MS2085A-xxxx-0099 Premium Calibration to ISO17025 and ANSI/NCSL Z540-1 plus test data
(xxxx is the frequency option number)

*Time-Limited Options

Options marked with an asterisk are offered as a 90-day time limited option by ordering as a -9xxx series option. For example, MS2085A-9003 is the 90-day time limited option for Time Domain Reflection Measurements. The option start time begins when the user first activates the option.

Supported PC Software

ARRT Anritsu Remote and Report Tools

- **United States**

- **Anritsu Americas Sales Company**

490 Jarvis Drive, Morgan Hill, CA 95037-2809, U.S.A.
Phone: +1-800-Anritsu (1-800-267-4878)

- **Canada**

- **Anritsu Electronics Ltd.**

- **Americas Sales and Support**

490 Jarvis Drive, Morgan Hill, CA 95037-2809, U.S.A.
Phone: +1-800-Anritsu (1-800-267-4878)

- **Brazil**

- **Anritsu Eletronica Ltda.**

Praça Amadeu Amaral, 27 - 1 Andar
01327-010 - Bela Vista - Sao Paulo - SP, Brazil
Phone: +55-11-3283-2511
Fax: +55-11-3288-6940

- **Mexico**

- **Anritsu Company, S.A. de C.V.**

Bldv Miguel de Cervantes Saavedra #169 Piso 1, Col. Granada
Mexico, Ciudad de Mexico, 11520, MEXICO
Phone: +52-55-4169-7104

- **United Kingdom**

- **Anritsu EMEA Ltd.**

200 Capability Green, Luton, Bedfordshire, LU1 3LU, U.K.
Phone: +44-1582-433200
Fax: +44-1582-731303

- **France**

- **Anritsu S.A.**

12 avenue du Québec, Immeuble Goyave,
91140 VILLEBON SUR YVETTE, France
Phone: +33-1-60-92-15-50

- **Germany**

- **Anritsu GmbH**

Nemetschek Haus, Konrad-Zuse-Platz 1,
81829 München, Germany
Phone: +49-89-442308-0
Fax: +49-89-442308-55

- **Italy**

- **Anritsu S.r.l.**

Spaces Eur Arte, Viale dell'Arte 25, 00144 Roma, Italy
Phone: +39-6-509-9711

- **Sweden**

- **Anritsu AB**

Kistagången 20 B, 2 tr, 164 40 Kista, Sweden
Phone: +46-8-534-707-00

- **Finland**

- **Anritsu AB**

Technopolis Aviapolis, Teknobulevardi 3-5 (D208.5.),
FI-01530 Vantaa, Finland
Phone: +358-20-741-8100

- **Denmark**

- **Anritsu A/S**

c/o Regus Winghouse, Ørestads Boulevard 73, 4th floor,
2300 Copenhagen S, Denmark
Phone: +45-7211-2200

- **Spain**

- **Anritsu EMEA GmbH**

- **Representation Office in Spain**

Calle Manzanares 4, Primera planta, 28005 Madrid, Spain
Phone: +34-91-572-6761

- **Austria**

- **Anritsu EMEA GmbH**

Am Belvedere 10, A-1100 Vienna, Austria
Phone: +43-(0)1-717-28-710

- **United Arab Emirates**

- **Anritsu A/S**

Office No. 164, Building 17, Dubai Internet City
P. O. Box – 501901, Dubai, United Arab Emirates
Phone: +971-4-3758479

- **India**

- **Anritsu India Private Limited**

6th Floor, Indique ETA, No.38/4, Adjacent to EMC2,
Doddanekundi, Outer Ring Road, Bengaluru – 560048, India
Phone: +91-80-6728-1300
Fax: +91-80-6728-1301

- **Singapore**

- **Anritsu Pte. Ltd.**

1 Jalan Kilang Timor, #07-04/06 Pacific Tech Centre
Singapore 159303
Phone: +65-6282-2400
Fax: +65-6282-2533

- **Vietnam**

- **Anritsu Company Limited**

16th Floor, Peakview Tower, 36 Hoang Cau Street, O Cho Dua Ward,
Dong Da District, Hanoi, Vietnam
Phone: +84-24-3201-2730

- **P.R. China (Shanghai)**

- **Anritsu (China) Co., Ltd.**

Room 2701-2705, Tower A, New Caohejing International
Business Center No. 391 Gui Ping Road Shanghai, 200233, P.R. China
Phone: +86-21-6237-0898
Fax: +86-21-6237-0899

- **P.R. China (Hong Kong)**

- **Anritsu Company Ltd.**

Unit 1006-7, 10/F., Greenfield Tower, Concordia Plaza,
No. 1 Science Museum Road, Tsim Sha Tsui East,
Kowloon, Hong Kong, P.R. China
Phone: +852-2301-4980
Fax: +852-2301-3545

- **Japan**

- **Anritsu Corporation**

8-5, Tamura-cho, Atsugi-shi, Kanagawa, 243-0016 Japan
Phone: +81-46-296-6509
Fax: +81-46-225-8352

- **Korea**

- **Anritsu Corporation, Ltd.**

8F, A TOWER, 20, Gwacheondaero 7-gil, Gwacheon-si,
Gyeonggi-do, 13840, Republic of Korea
Phone: +82-2-6259-7300
Fax: +82-2-6259-7301

- **Australia**

- **Anritsu Pty. Ltd.**

Unit 20, 21-35 Ricketts Road, Mount Waverley, Victoria 3149, Australia
Phone: +61-3-9558-8177
Fax: +61-3-9558-8255

- **Taiwan**

- **Anritsu Company Inc.**

7F, No. 316, Sec. 1, NeiHu Rd., Taipei 114, Taiwan
Phone: +886-2-8751-1816
Fax: +886-2-8751-1817

List Revision Date: 20240416



Anritsu utilizes recycled paper and environmentally conscious inks and toner.



© Anritsu All trademarks are registered trademarks of their respective owners. Data subject to change without notice. For the most recent specifications visit: www.anritsu.com